

Catalogue avec tarifs
Meules pour centre numérique CNC toutes marques

Choix + Qualité

*Veloces
Line*



COMARTEX

☎ 01 45 76 53 03

☎ 01 45 76 76 82

mail : comartex@comartex.fr

site : www.comartex.com



De la qualité, des prix et du choix...

La preuve en vidéo sur le

www.COMARTEX.com

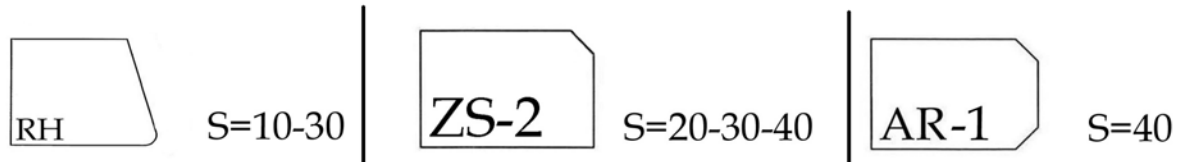
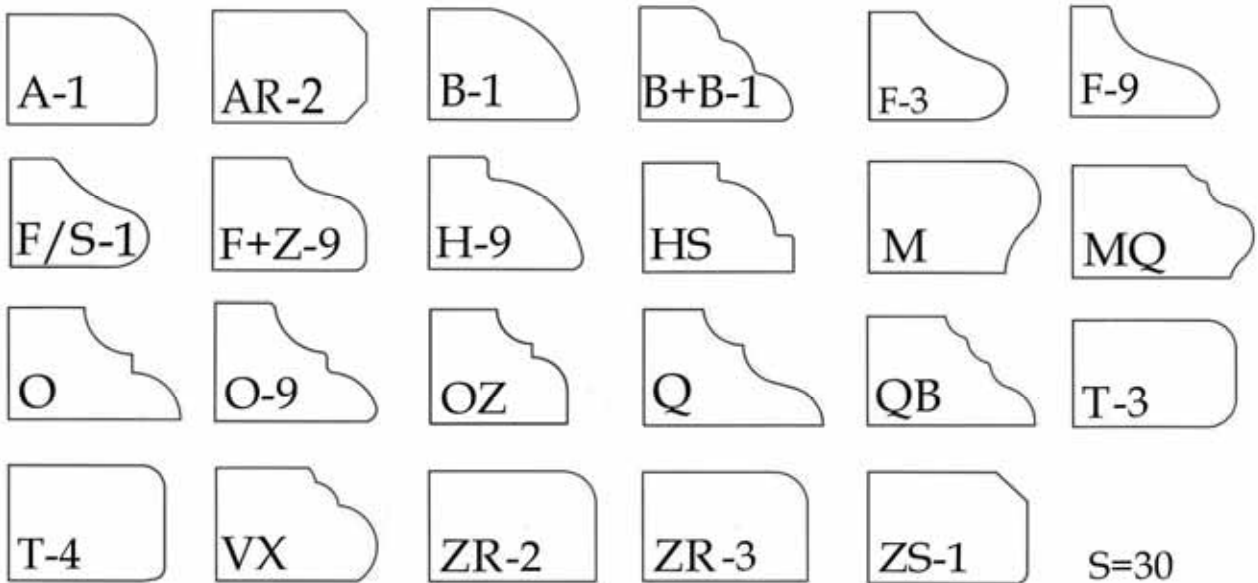
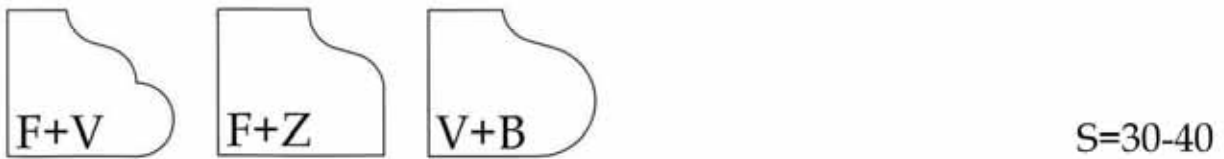
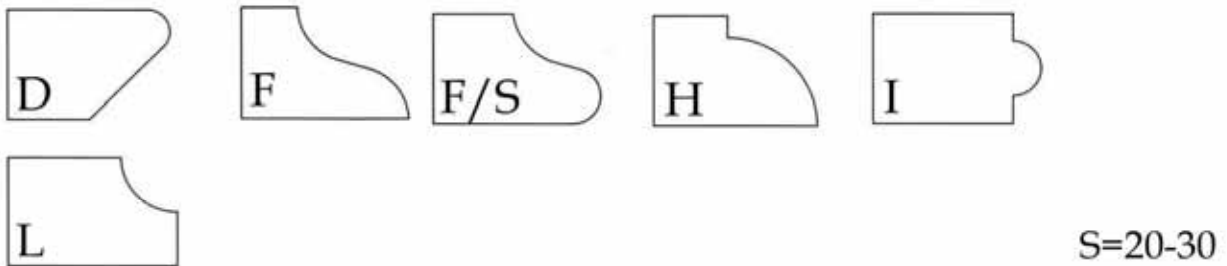
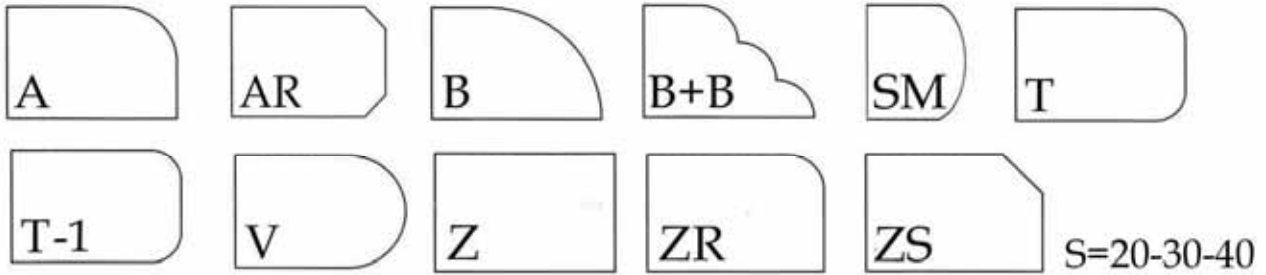

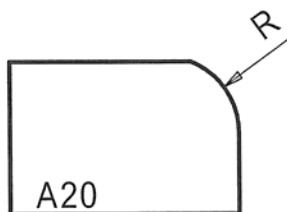

R=10 mm

FORO STANDARD 35 mm / Standard Bore 35 mm

-Spessore lastra 20 mm / Slab Thickness 20 mm

CODICE CODE	TIPO MOLA WHEEL TYPE	DIAMETRO DIAMETER	SEQUENZA SEQUENCE	POS	Prezzo Price [€uro]
PB01001	Settori / Segmented	83	1	1	342
PB01002	Fascia Continua / Continuous Rim		2	2	333
PB01003	Fascia Continua / Continuous Rim		3	3	333
PB02002	<i>Express</i>	94	4	6	150
PB02003	<i>Express</i>		5	7	150

COMARTEX

☎ 01 45 76 53 03
 ☎ 01 45 76 76 82
 mail : comartex@comartex.fr
 site : www.comartex.com



De la qualité, des prix et du choix...
 La preuve en vidéo sur le
 www. **COMARTEX** .com

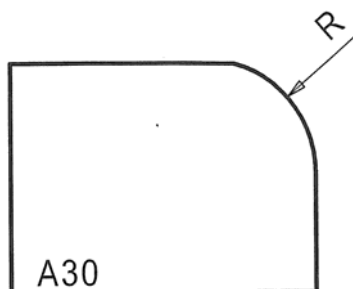

R=15 mm

FORO STANDARD 35 mm / Standard Bore 35 mm

-Spessore lastra 30 mm / Slab Thickness 30 mm

CODICE CODE	TIPO MOLA WHEEL TYPE	DIAMETRO DIAMETER	SEQUENZA SEQUENCE	POS	Prezzo Price [€uro]
PB01004	Settori / Segmented	90	1	1	380
PB01005	Fascia Continua / Continuous Rim		2	2	371
PB01006	Fascia Continua / Continuous Rim		3	3	371
PB02005	<i>Express</i>	95	4	6	163
PB02006	<i>Express</i>		5	7	163

COMARTEX

☎ 01 45 76 53 03
 ☎ 01 45 76 76 82
 mail : comartex@comartex.fr
 site : www.comartex.com



De la qualité, des prix et du choix...
 La preuve en vidéo sur le
 www. **COMARTEX** .com

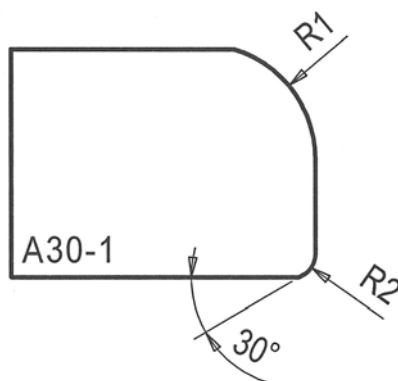

R1 = 15mm R2 = 3mm

FORO STANDARD 35 mm / Standard Bore 35 mm

-Spessore lastra 30 mm / Slab Thickness 30 mm

CODICE CODE	TIPO MOLA WHEEL TYPE	DIAMETRO DIAMETER	SEQUENZA SEQUENCE	POS	Prezzo Price [€uro]
PB01004	Settori / Segmented	90	1	1	380
PB01035	Fascia Continua / Continuous Rim		2	2	408
PB01036	Fascia Continua / Continuous Rim		3	3	408
PB02008	<i>Express</i>	97	4	6	180
PB02009	<i>Express</i>		5	7	180

COMARTEX

☎ 01 45 76 53 03

☎ 01 45 76 76 82

mail : comartex@comartex.fr



ADI S.p.A. Via Dell'Economia,12/16
 36016 Thiene (VI) Italy Tel. 0445 / 360244 Fax 0445/366862
 Fax Stone Division +39 0445/377555
 www.aditools.com E-mail: info@aditools.com



De la qualité, des prix et du choix...

La preuve en vidéo sur le

www. **COMARTEX** .com



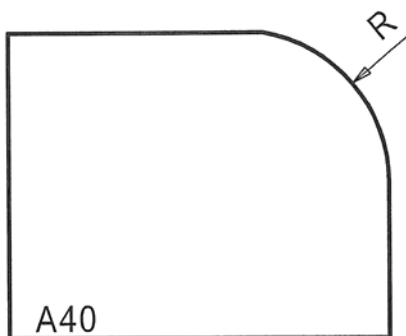

R=20 mm

FORO STANDARD 35 mm / Standard Bore 35 mm

-Spessore lastra 40 mm / Slab Thickness 40 mm

CODICE CODE	TIPO MOLA WHEEL TYPE	DIAMETRO DIAMETER	SEQUENZA SEQUENCE	POS	Prezzo Price [€uro]
PB01007	Settori / Segmented	97	1	1	418
PB01008	Fascia Continua / Continuous Rim		2	2	418
PB01009	Fascia Continua / Continuous Rim		3	3	418
PB02011	<i>Express</i>	113	4	6	206
PB02012	<i>Express</i>		5	7	206

COMARTEX

☎ 01 45 76 53 03

☎ 01 45 76 76 82

mail : comartex@comartex.fr



ADI S.p.A. Via Dell'Economia,12/16
 36016 Thiene (VI) Italy Tel. 0445 / 360244 Fax 0445/366862
 Fax Stone Division +39 0445/377555
 www.aditools.com E-mail: info@aditools.com



De la qualité, des prix et du choix...

La preuve en vidéo sur le

www. **COMARTEX** .com



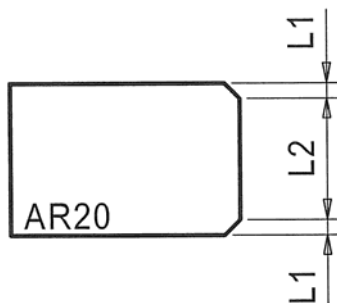

L1 = 2 mm L2 = 16 mm

FORO STANDARD 35 mm / Standard Bore 35 mm

-Spessore lastra 20 mm / Slab Thickness 20 mm

CODICE CODE	TIPO MOLA WHEEL TYPE	DIAMETRO DIAMETER	SEQUENZA SEQUENCE	POS	Prezzo Price [€uro]
PB01019	Settori / Segmented	78	1	1	380
PB01020	Fascia Continua / Continuous Rim		2	2	380
PB01021	Fascia Continua / Continuous Rim		3	3	380
PB02014	<i>Express</i>	70	4	6	124
PB02015	<i>Express</i>		5	7	124

COMARTEX

☎ 01 45 76 53 03

☎ 01 45 76 76 82

mail : comartex@comartex.fr



ADI S.p.A. Via Dell'Economia, 12/16
 36016 Thiene (VI) Italy Tel. 0445 / 360244 Fax 0445/366862
 Fax Stone Division +39 0445/377555
 www.aditools.com E-mail: info@aditools.com



De la qualité, des prix et du choix...

La preuve en vidéo sur le

www.COMARTEX.com



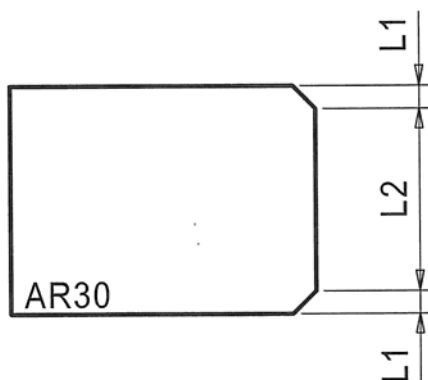

L1 = 3 mm L2 = 24 mm

FORO STANDARD 35 mm / Standard Bore 35 mm

-Spessore lastra 30 mm / Slab Thickness 30 mm

CODICE CODE	TIPO MOLA WHEEL TYPE	DIAMETRO DIAMETER	SEQUENZA SEQUENCE	POS	Prezzo Price [€uro]
PB01022	Fascia Continua / <i>Continuous Rim</i>	80	1	1	418
PB01023	Fascia Continua / <i>Continuous Rim</i>		2	2	418
PB01024	Fascia Continua / <i>Continuous Rim</i>		3	3	418
PB02017	<i>Express</i>	80	4	6	133
PB02018	<i>Express</i>		5	7	133

COMARTEX

☎ 01 45 76 53 03

☎ 01 45 76 76 82

mail : comartex@comartex.fr



ADI S.p.A. Via Dell'Economia, 12/16
 36016 Thiene (VI) Italy Tel. 0445 / 360244 Fax 0445/366862
 Fax Stone Division +39 0445/377555
 www.aditools.com E-mail: info@aditools.com



De la qualité, des prix et du choix...

La preuve en vidéo sur le

www.COMARTEX.com



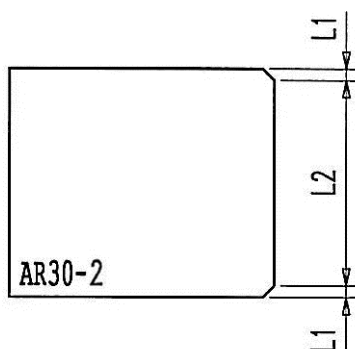

L1 = 2 mm L2 = 26 mm

FORO STANDARD 35 mm / Standard Bore 35 mm

-Spessore lastra 30 mm / Slab Thickness 30 mm

CODICE CODE	TIPO MOLA WHEEL TYPE	DIAMETRO DIAMETER	SEQUENZA SEQUENCE	POS	Prezzo Price [€uro]
PB01025	Settori / Segmented	80	1	1	418
PB01026	Fascia Continua / Continuous Rim		2	2	418
PB01027	Fascia Continua / Continuous Rim		3	3	418
PB02020	<i>Express</i>	80	4	6	133
PB02021	<i>Express</i>		5	7	133

COMARTEX

☎ 01 45 76 53 03

☎ 01 45 76 76 82

mail : comartex@comartex.fr



ADI S.p.A. Via Dell'Economia, 12/16
 36016 Thiene (VI) Italy Tel. 0445 / 360244 Fax 0445/366862
 Fax Stone Division +39 0445/377555
 www.aditools.com E-mail: info@aditools.com



De la qualité, des prix et du choix...

La preuve en vidéo sur le

www.COMARTEX.com



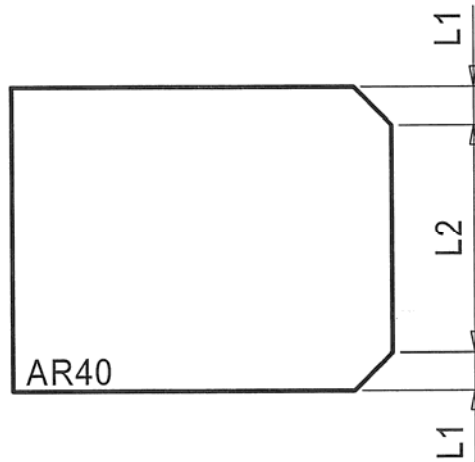

L1 = 5 mm L2 = 30 mm

FORO STANDARD 35 mm / Standard Bore 35 mm

-Spessore lastra 40 mm / Slab Thickness 40 mm

CODICE CODE	TIPO MOLA WHEEL TYPE	DIAMETRO DIAMETER	SEQUENZA SEQUENCE	POS	Prezzo Price [€uro]
PB01028	Settori / Segmented	80	1	1	466
PB01029	Fascia Continua / Continuous Rim		2	2	466
PB01030	Fascia Continua / Continuous Rim		3	3	466
PB02023	<i>Express</i>	80	4	6	155
PB02024	<i>Express</i>		5	7	155

COMARTEX

☎ 01 45 76 53 03
☎ 01 45 76 76 82
mail : comartex@comartex.fr



ADI S.p.A. Via Dell'Economia, 12/16
36016 Thiene (VI) Italy Tel. 0445 / 360244 Fax 0445/366862
Fax Stone Division +39 0445/377555 10
www.aditools.com E-mail: info@aditools.com



De la qualité, des prix et du choix...

La preuve en vidéo sur le

www.COMARTEX.com



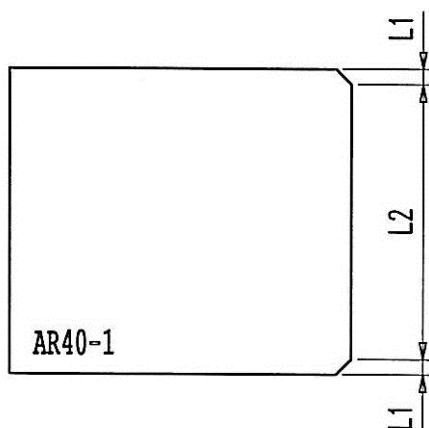

L1 = 2 mm L2 = 36 mm

FORO STANDARD 35 mm / Standard Bore 35 mm

-Spessore lastra 40 mm / Slab Thickness 40 mm

CODICE CODE	TIPO MOLLA WHEEL TYPE	DIAMETRO DIAMETER	SEQUENZA SEQUENCE	POS	Prezzo Price [€uro]
PB01031	Settori / Segmented	84	1	1	466
PB01032	Fascia Continua / Continuous Rim		2	2	466
PB01033	Fascia Continua / Continuous Rim		3	3	466
PB02026	<i>Express</i>	80	4	6	155
PB02027	<i>Express</i>		5	7	155

COMARTEX

☎ 01 45 76 53 03

☎ 01 45 76 76 82

mail : comartex@comartex.fr



ADI S.p.A. Via Dell'Economia, 12/16
 36016 Thiene (VI) Italy Tel. 0445 / 360244 Fax 0445/366862
 Fax Stone Division +39 0445/377555
 www.aditools.com E-mail: info@aditools.com



De la qualité, des prix et du choix...

La preuve en vidéo sur le

www.COMARTEX.com



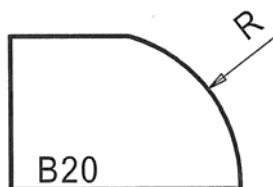

R=20 mm

FORO STANDARD 35 mm / Standard Bore 35 mm

-Spessore lastra 20 mm / Slab Thickness 20 mm

CODICE CODE	TIPO MOLA WHEEL TYPE	DIAMETRO DIAMETER	SEQUENZA SEQUENCE	POS	Prezzo Price [€uro]
PB01037	Settori / Segmented	100	1	1	360
PB01038	Fascia Continua / Continuous Rim		2	2	370
PB01039	Fascia Continua / Continuous Rim		3	3	370
PB02029	<i>Express</i>	115	4	6	163
PB02030	<i>Express</i>		5	7	163

COMARTEX

☎ 01 45 76 53 03

☎ 01 45 76 76 82

mail : comartex@comartex.fr



ADI S.p.A. Via Dell'Economia,12/16
 36016 Thiene (VI) Italy Tel. 0445 / 360244 Fax 0445/366862
 Fax Stone Division +39 0445/377555
 www.aditools.com E-mail: info@aditools.com



De la qualité, des prix et du choix...

La preuve en vidéo sur le

www.COMARTEX.com



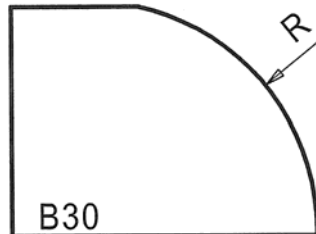

R=30 mm

FORO STANDARD 35 mm / Standard Bore 35 mm

-Spessore lastra 30 mm / Slab Thickness 30 mm

CODICE CODE	TIPO MOLA WHEEL TYPE	DIAMETRO DIAMETER	SEQUENZA SEQUENCE	POS	Prezzo Price [€uro]
PB01040	Settori / Segmented	120	1	1	450
PB01041	Fascia Continua / Continuous Rim		2	2	493
PB01042	Fascia Continua / Continuous Rim		3	3	493
PB02032	<i>Express</i>	130	4	6	183
PB02033	<i>Express</i>		5	7	183

COMARTEX

☎ 01 45 76 53 03

☎ 01 45 76 76 82

mail : comartex@comartex.fr



ADI S.p.A. Via Dell'Economia,12/16
 36016 Thiene (VI) Italy Tel. 0445 / 360244 Fax 0445/366862
 Fax Stone Division +39 0445/377555
 www.aditools.com E-mail: info@aditools.com



De la qualité, des prix et du choix...

La preuve en vidéo sur le

www.COMARTEX.com



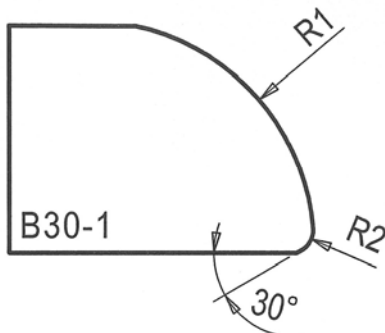

R1=30 mm R2= 3mm

FORO STANDARD 35 mm / Standard Bore 35 mm

-Spessore lastra 30 mm / Slab Thickness 30 mm

CODICE CODE	TIPO MOLA WHEEL TYPE	DIAMETRO DIAMETER	SEQUENZA SEQUENCE	POS	Prezzo Price [€uro]
PB01040	Settori / Segmented	120	1	1	450
PB01044	Fascia Continua / Continuous Rim		2	2	542
PB01045	Fascia Continua / Continuous Rim		3	3	542
PB02035	<i>Express</i>	130	4	6	210
PB02036	<i>Express</i>		5	7	210

COMARTEX

☎ 01 45 76 53 03

☎ 01 45 76 76 82

mail : comartex@comartex.fr



ADI S.p.A. Via Dell'Economia,12/16
 36016 Thiene (VI) Italy Tel. 0445 / 360244 Fax 0445/366862
 Fax Stone Division +39 0445/377555
 www.aditools.com E-mail: info@aditools.com



De la qualité, des prix et du choix...

La preuve en vidéo sur le

www.COMARTEX.com



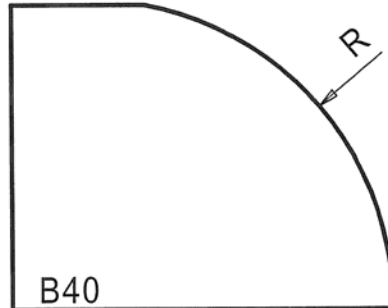

R=40 mm

FORO STANDARD 35 mm / Standard Bore 35 mm

-Spessore lastra 40 mm / Slab Thickness 40 mm

CODICE CODE	TIPO MOLA WHEEL TYPE	DIAMETRO DIAMETER	SEQUENZA SEQUENCE	POS	Prezzo Price [€uro]
PB01046	Settori / Segmented	150	1	1	519
PB01047	Fascia Continua / Continuous Rim		2	2	573
PB01048	Fascia Continua / Continuous Rim		3	3	573
PB02038	<i>Express</i>	140	4	6	206
PB02039	<i>Express</i>		5	7	206

COMARTEX

☎ 01 45 76 53 03
☎ 01 45 76 76 82
mail : comartex@comartex.fr



ADI S.p.A. Via Dell'Economia,12/16
36016 Thiene (VI) Italy Tel. 0445 / 360244 Fax 0445/366862
Fax Stone Division +39 0445/377555
www.aditools.com E-mail: info@aditools.com



De la qualité, des prix et du choix...

La preuve en vidéo sur le

www.COMARTEX.com



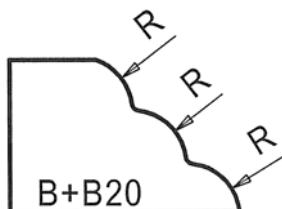

R=7 mm

FORO STANDARD 35 mm / Standard Bore 35 mm

-Spessore lastra 20 mm / Slab Thickness 20 mm

CODICE CODE	TIPO MOLA WHEEL TYPE	DIAMETRO DIAMETER	SEQUENZA SEQUENCE	POS	Prezzo Price [€uro]
PB01049	Settori / Segmented	120	1	1	475
PB01050	Fascia Continua / Continuous Rim		2	2	475
PB01051	Fascia Continua / Continuous Rim		3	3	475
PB02041	<i>Express</i>	110	4	6	183
PB02042	<i>Express</i>		5	7	183

COMARTEX

☎ 01 45 76 53 03

☎ 01 45 76 76 82

mail : comartex@comartex.fr



ADI S.p.A. Via Dell'Economia,12/16
 36016 Thiene (VI) Italy Tel. 0445 / 360244 Fax 0445/366862
 Fax Stone Division +39 0445/377555
 www.aditools.com E-mail: info@aditools.com



De la qualité, des prix et du choix...

La preuve en vidéo sur le

www.COMARTEX.com



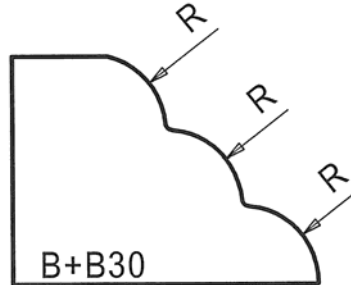

R= 10 mm

FORO STANDARD 35 mm / Standard Bore 35 mm

-Spessore lastra 30 mm / Slab Thickness 30 mm

CODICE CODE	TIPO MOLA WHEEL TYPE	DIAMETRO DIAMETER	SEQUENZA SEQUENCE	POS	Prezzo Price [€uro]
PB01052	Settori / Segmented	120	1	1	532
PB01053	Fascia Continua / Continuous Rim		2	2	532
PB01054	Fascia Continua / Continuous Rim		3	3	532
PB02044	<i>Express</i>	125	4	6	214
PB02045	<i>Express</i>		5	7	214

COMARTEX

☎ 01 45 76 53 03
☎ 01 45 76 76 82
mail : comartex@comartex.fr



ADI S.p.A. Via Dell'Economia,12/16
36016 Thiene (VI) Italy Tel. 0445 / 360244 Fax 0445/366862
Fax Stone Division +39 0445/377555
www.aditools.com E-mail: info@aditools.com



De la qualité, des prix et du choix...

La preuve en vidéo sur le

www.COMARTEX.com



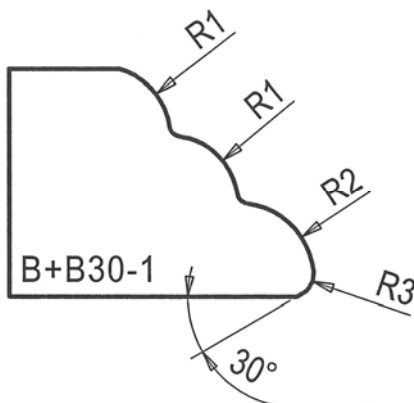

R1=9 mm R2=10 mm R3= 3 mm

FORO STANDARD 35 mm / Standard Bore 35 mm

-Spessore lastra 30 mm / Slab Thickness 30 mm

CODICE CODE	TIPO MOLA WHEEL TYPE	DIAMETRO DIAMETER	SEQUENZA SEQUENCE	POS	Prezzo Price [€uro]
PB01055	Settori / Segmented	120	1	1	532
PB01056	Fascia Continua / Continuous Rim		2	2	585
PB01057	Fascia Continua / Continuous Rim		3	3	585
PB02047	<i>Express</i>	125	4	6	245
PB02048	<i>Express</i>		5	7	245

COMARTEX

☎ 01 45 76 53 03

☎ 01 45 76 76 82

mail : comartex@comartex.fr



ADI S.p.A. Via Dell'Economia,12/16
 36016 Thiene (VI) Italy Tel. 0445 / 360244 Fax 0445/366862
 Fax Stone Division +39 0445/377555
 www.aditools.com E-mail: info@aditools.com



De la qualité, des prix et du choix...

La preuve en vidéo sur le

www.COMARTEX.com



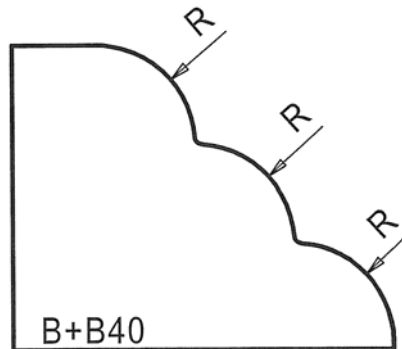

R=13 mm

FORO STANDARD 35 mm / Standard Bore 35 mm

-Spessore lastra 40 mm / Slab Thickness 40 mm

CODICE CODE	TIPO MOLA WHEEL TYPE	DIAMETRO DIAMETER	SEQUENZA SEQUENCE	POS	Prezzo Price [€uro]
PB01058	Settori / Segmented	150	1	1	771
PB01059	Fascia Continua / Continuous Rim		2	2	735
PB01060	Fascia Continua / Continuous Rim		3	3	735
PB02050	<i>Express</i>	145	4	6	245
PB02051	<i>Express</i>		5	7	245

COMARTEX

☎ 01 45 76 53 03
☎ 01 45 76 76 82
mail : comartex@comartex.fr



ADI S.p.A. Via Dell'Economia,12/16
36016 Thiene (VI) Italy Tel. 0445 / 360244 Fax 0445/366862
Fax Stone Division +39 0445/377555
www.aditools.com E-mail: info@aditools.com



De la qualité, des prix et du choix...

La preuve en vidéo sur le

www.COMARTEX.com



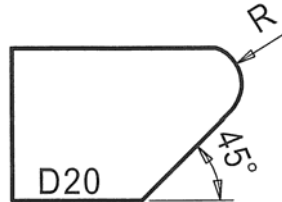

R= 5 mm - 45°

FORO STANDARD 35 mm / Standard Bore 35 mm

-Spessore lastra 20 mm / Slab Thickness 20 mm

CODICE CODE	TIPO MOLA WHEEL TYPE	DIAMETRO DIAMETER	SEQUENZA SEQUENCE	POS	Prezzo Price [€uro]
PB01061	Settori / Segmented	120	1	1	428
PB01062	Fascia Continua / Continuous Rim		2	2	456
PB01063	Fascia Continua / Continuous Rim		3	3	456
PB02053	<i>Express</i>	100	4	6	183
PB02054	<i>Express</i>		5	7	183

COMARTEX

☎ 01 45 76 53 03
☎ 01 45 76 76 82
mail : comartex@comartex.fr



ADI S.p.A. Via Dell'Economia,12/16
36016 Thiene (VI) Italy Tel. 0445 / 360244 Fax 0445/366862
Fax Stone Division +39 0445/377555
www.aditools.com E-mail: info@aditools.com



De la qualité, des prix et du choix...

La preuve en vidéo sur le

www.COMARTEX.com



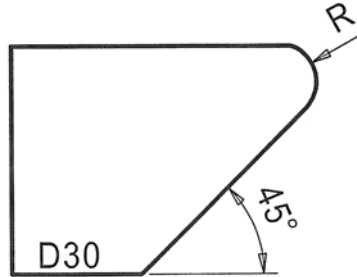

R= 5 mm - 45°

FORO STANDARD 35 mm / Standard Bore 35 mm

-Spessore lastra 30 mm / Slab Thickness 30 mm

CODICE CODE	TIPO MOLA WHEEL TYPE	DIAMETRO DIAMETER	SEQUENZA SEQUENCE	POS	Prezzo Price [€uro]
PB01064	Settori / Segmented	120	1	1	475
PB01065	Fascia Continua / Continuous Rim		2	2	504
PB01066	Fascia Continua / Continuous Rim		3	3	504
PB02056	<i>Express</i>	120	4	6	215
PB02057	<i>Express</i>		5	7	215

COMARTEX

☎ 01 45 76 53 03
☎ 01 45 76 76 82
mail : comartex@comartex.fr



ADI S.p.A. Via Dell'Economia,12/16
36016 Thiene (VI) Italy Tel. 0445 / 360244 Fax 0445/366862
Fax Stone Division +39 0445/377555
www.aditools.com E-mail: info@aditools.com



De la qualité, des prix et du choix...

La preuve en vidéo sur le

www.COMARTEX.com



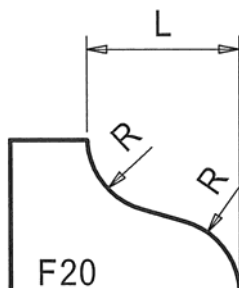

L=20 mm R=10 + 10 mm

FORO STANDARD 35 mm / Standard Bore 35 mm

-Spessore lastra 20 mm / Slab Thickness 20 mm

CODICE CODE	TIPO MOLA WHEEL TYPE	DIAMETRO DIAMETER	SEQUENZA SEQUENCE	POS	Prezzo Price [€uro]
PB01067	Settori / Segmented	120	1	1	428
PB01068	Fascia Continua / Continuous Rim		2	2	456
PB01069	Fascia Continua / Continuous Rim		3	3	456
PB02059	<i>Express</i>	100	4	6	183
PB02060	<i>Express</i>		5	7	183

COMARTEX

☎ 01 45 76 53 03

☎ 01 45 76 76 82

mail : comartex@comartex.fr



ADI S.p.A. Via Dell'Economia,12/16
36016 Thiene (VI) Italy Tel. 0445 / 360244 Fax 0445/366862
Fax Stone Division +39 0445/377555
www.aditools.com E-mail: info@aditools.com



De la qualité, des prix et du choix...

La preuve en vidéo sur le

www.COMARTEX.com



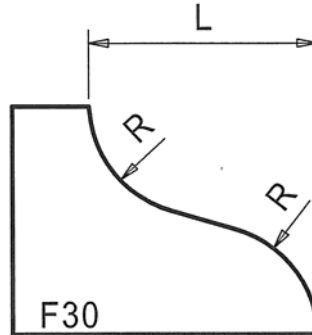

L=30 mm R=15 + 15 mm

FORO STANDARD 35 mm / Standard Bore 35 mm

-Spessore lastra 30 mm / Slab Thickness 30 mm

CODICE CODE	TIPO MOLA WHEEL TYPE	DIAMETRO DIAMETER	SEQUENZA SEQUENCE	POS	Prezzo Price [€uro]
PB01070	Settori / Segmented	130	1	1	475
PB01071	Fascia Continua / Continuous Rim		2	2	504
PB01072	Fascia Continua / Continuous Rim		3	3	504
PB02062	<i>Express</i>	120	4	6	215
PB02063	<i>Express</i>		5	7	215

COMARTEX

☎ 01 45 76 53 03
☎ 01 45 76 76 82
mail : comartex@comartex.fr



ADI S.p.A. Via Dell'Economia,12/16
36016 Thiene (VI) Italy Tel. 0445 / 360244 Fax 0445/366862
Fax Stone Division +39 0445/377555
www.aditools.com E-mail: info@aditools.com



De la qualité, des prix et du choix...

La preuve en vidéo sur le

www.COMARTEX.com



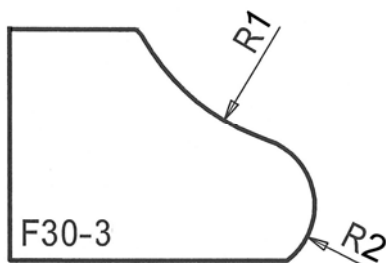

R1= 30 mm R2= 9 mm

FORO STANDARD 35 mm / Standard Bore 35 mm

-Spessore lastra 30 mm / Slab Thickness 30 mm

CODICE CODE	TIPO MOLA WHEEL TYPE	DIAMETRO DIAMETER	SEQUENZA SEQUENCE	POS	Prezzo Price [€uro]
PB01073	Settori / Segmented	118	1	1	546
PB01074	Fascia Continua / Continuous Rim	114	2	2	580
PB01075	Fascia Continua / Continuous Rim		3	3	580
PB02065	<i>Express</i>	110	4	6	235
PB02066	<i>Express</i>		5	7	235

COMARTEX

☎ 01 45 76 53 03

☎ 01 45 76 76 82

mail : comartex@comartex.fr



ADI S.p.A. Via Dell'Economia,12/16
 36016 Thiene (VI) Italy Tel. 0445 / 360244 Fax 0445/366862
 Fax Stone Division +39 0445/377555
 www.aditools.com E-mail: info@aditools.com



De la qualité, des prix et du choix...

La preuve en vidéo sur le

www.COMARTEX.com



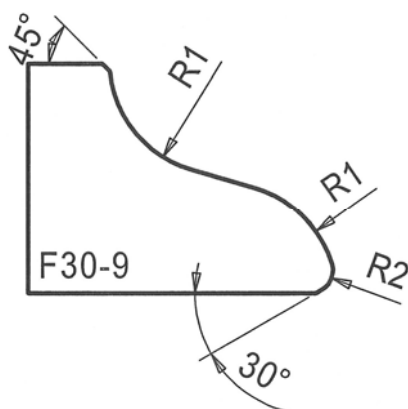

R1=15mm R2=3 mm

FORO STANDARD 35 mm / *Standard Bore 35 mm*

-Spessore lastra 30 mm / *Slab Thickness 30 mm*

CODICE CODE	TIPO MOLA WHEEL TYPE	DIAMETRO DIAMETER	SEQUENZA SEQUENCE	POS	Prezzo Price [€uro]
PB01070	Settori / Segmented	120	1	1	475
PB01077	Fascia Continua / <i>Continuous Rim</i>		2	2	580
PB01078	Fascia Continua / <i>Continuous Rim</i>		3	3	580
PB02068	<i>Express</i>	120	4	6	247
PB02069	<i>Express</i>		5	7	247

COMARTEX

☎ 01 45 76 53 03

☎ 01 45 76 76 82

mail : comartex@comartex.fr



ADI S.p.A. Via Dell'Economia,12/16
 36016 Thiene (VI) Italy Tel. 0445 / 360244 Fax 0445/366862
 Fax Stone Division +39 0445/377555
 www.aditools.com E-mail: info@aditools.com



De la qualité, des prix et du choix...

La preuve en vidéo sur le

www.COMARTEX.com





R1= 11 mm R2= 5 mm

FORO STANDARD 35 mm / Standard Bore 35 mm

-Spessore lastra 20 mm / Slab Thickness 20 mm

CODICE CODE	TIPO MOLA WHEEL TYPE	DIAMETRO DIAMETER	SEQUENZA SEQUENCE	POS	Prezzo Price [€uro]
PB01079	Settori / Segmented	120	1	1	492
PB01080	Fascia Continua / Continuous Rim		2	2	524
PB01081	Fascia Continua / Continuous Rim		3	3	524
PB02071	<i>Express</i>	100	4	6	203
PB02072	<i>Express</i>		5	7	203

COMARTEX

☎ 01 45 76 53 03

☎ 01 45 76 76 82

mail : comartex@comartex.fr



ADI S.p.A. Via Dell'Economia,12/16
 36016 Thiene (VI) Italy Tel. 0445 / 360244 Fax 0445/366862
 Fax Stone Division +39 0445/377555
 www.aditools.com E-mail: info@aditools.com



De la qualité, des prix et du choix...

La preuve en vidéo sur le

www. **COMARTEX** .com



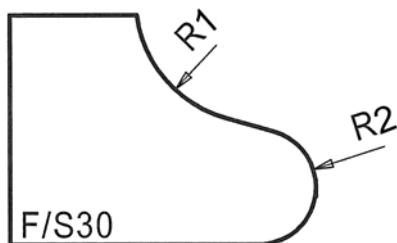

R1= 16 mm R2= 7,5 mm

FORO STANDARD 35 mm / Standard Bore 35 mm

-Spessore lastra 30 mm / Slab Thickness 30 mm

CODICE CODE	TIPO MOLA WHEEL TYPE	DIAMETRO DIAMETER	SEQUENZA SEQUENCE	POS	Prezzo Price [€uro]
PB01082	Settori / Segmented	120	1	1	546
PB01083	Fascia Continua / Continuous Rim		2	2	580
PB01084	Fascia Continua / Continuous Rim		3	3	580
PB02074	<i>Express</i>	120	4	6	236
PB02075	<i>Express</i>		5	7	236

COMARTEX

☎ 01 45 76 53 03

☎ 01 45 76 76 82

mail : comartex@comartex.fr



ADI S.p.A. Via Dell'Economia,12/16
 36016 Thiene (VI) Italy Tel. 0445 / 360244 Fax 0445/366862
 Fax Stone Division +39 0445/377555
 www.aditools.com E-mail: info@aditools.com



De la qualité, des prix et du choix...

La preuve en vidéo sur le

www. **COMARTEX** .com



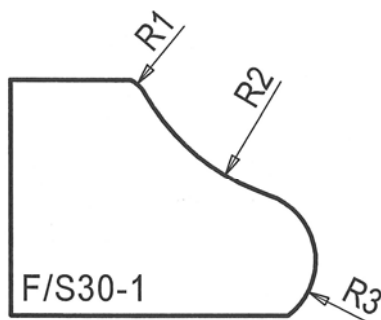

R1= 4,5mm R2= 30 mm R3= 9mm

FORO STANDARD 35 mm / Standard Bore 35 mm

-Spessore lastra 30 mm / Slab Thickness 30 mm

CODICE CODE	TIPO MOLA WHEEL TYPE	DIAMETRO DIAMETER	SEQUENZA SEQUENCE	POS	Prezzo Price [€uro]
PB01085	Settori / Segmented	120	1	1	570
PB01086	Fascia Continua / Continuous Rim		2	2	604
PB01087	Fascia Continua / Continuous Rim		3	3	604
PB02077	<i>Express</i>	120	4	6	245
PB02078	<i>Express</i>		5	7	245

COMARTEX

☎ 01 45 76 53 03

☎ 01 45 76 76 82

mail : comartex@comartex.fr



ADI S.p.A. Via Dell'Economia,12/16
 36016 Thiene (VI) Italy Tel. 0445 / 360244 Fax 0445/366862
 Fax Stone Division +39 0445/377555
 www.aditools.com E-mail: info@aditools.com



De la qualité, des prix et du choix...

La preuve en vidéo sur le

www. **COMARTEX** .com



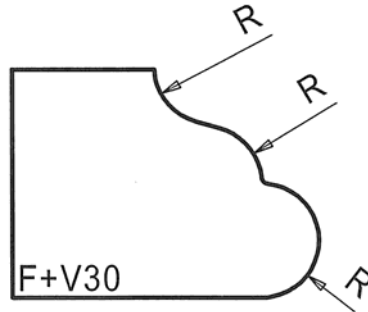

R= 7,5 mm

FORO STANDARD 35 mm / Standard Bore 35 mm

-Spessore lastra 30 mm / Slab Thickness 30 mm

CODICE CODE	TIPO MOLA WHEEL TYPE	DIAMETRO DIAMETER	SEQUENZA SEQUENCE	POS	Prezzo Price [€uro]
PB01088	Settori / Segmented	120	1	1	570
PB01089	Fascia Continua / Continuous Rim		2	2	604
PB01090	Fascia Continua / Continuous Rim		3	3	604
PB02080	<i>Express</i>	110	4	6	236
PB02081	<i>Express</i>		5	7	236

COMARTEX

☎ 01 45 76 53 03
☎ 01 45 76 76 82
mail : comartex@comartex.fr



ADI S.p.A. Via Dell'Economia,12/16
36016 Thiene (VI) Italy Tel. 0445 / 360244 Fax 0445/366862
Fax Stone Division +39 0445/377555
www.aditools.com E-mail: info@aditools.com



De la qualité, des prix et du choix...

La preuve en vidéo sur le

www.COMARTEX.com



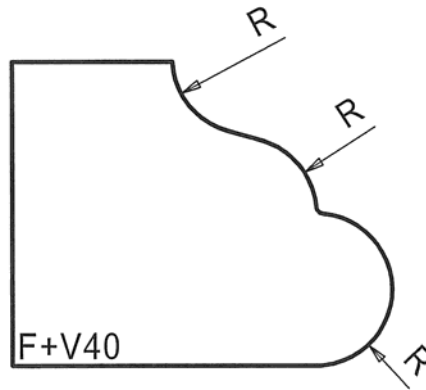

R= 10 mm

FORO STANDARD 35 mm / Standard Bore 35 mm

-Spessore lastra 40 mm / Slab Thickness 40 mm

CODICE CODE	TIPO MOLA WHEEL TYPE	DIAMETRO DIAMETER	SEQUENZA SEQUENCE	POS	Prezzo Price [€uro]
PB01091	Settori / Segmented	120	1	1	656
PB01092	Fascia Continua / Continuous Rim		2	2	690
PB01093	Fascia Continua / Continuous Rim		3	3	690
PB02083	<i>Express</i>	120	4	6	265
PB02084	<i>Express</i>		5	7	265

COMARTEX

☎ 01 45 76 53 03
☎ 01 45 76 76 82
mail : comartex@comartex.fr



ADI S.p.A. Via Dell'Economia,12/16
36016 Thiene (VI) Italy Tel. 0445 / 360244 Fax 0445/366862
Fax Stone Division +39 0445/377555
www.aditools.com E-mail: info@aditools.com



De la qualité, des prix et du choix...

La preuve en vidéo sur le

www.COMARTEX.com



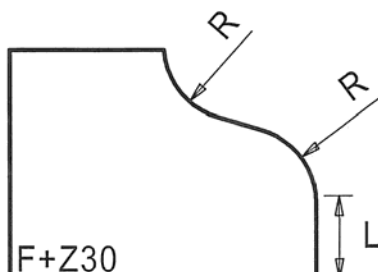

R= 10 mm L = 10 mm

FORO STANDARD 35 mm / Standard Bore 35 mm

-Spessore lastra 30 mm / Slab Thickness 30 mm

CODICE CODE	TIPO MOLA WHEEL TYPE	DIAMETRO DIAMETER	SEQUENZA SEQUENCE	POS	Prezzo Price [€uro]
PB01094	Settori / Segmented	95	1	1	428
PB01095	Fascia Continua / Continuous Rim	90	2	2	422
PB01096	Fascia Continua / Continuous Rim		3	3	422
PB02086	<i>Express</i>	100	4	6	215
PB02087	<i>Express</i>		5	7	215

COMARTEX

☎ 01 45 76 53 03

☎ 01 45 76 76 82

mail : comartex@comartex.fr



ADI S.p.A. Via Dell'Economia,12/16
 36016 Thiene (VI) Italy Tel. 0445 / 360244 Fax 0445/366862
 Fax Stone Division +39 0445/377555
 www.aditools.com E-mail: info@aditools.com



De la qualité, des prix et du choix...

La preuve en vidéo sur le

www.COMARTEX.com



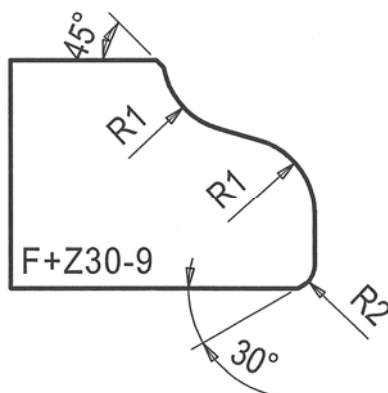

R1= 10 mm R2= 3 mm

FORO STANDARD 35 mm / Standard Bore 35 mm

-Spessore lastra 30 mm / Slab Thickness 30 mm

CODICE CODE	TIPO MOLA WHEEL TYPE	DIAMETRO DIAMETER	SEQUENZA SEQUENCE	POS	Prezzo Price [€uro]
PB01094	Settori / Segmented	95	1	1	428
PB01098	Fascia Continua / Continuous Rim	104	2	2	485
PB01099	Fascia Continua / Continuous Rim		3	3	485
PB02089	<i>Express</i>	100	4	6	247
PB02090	<i>Express</i>		5	7	247

COMARTEX

☎ 01 45 76 53 03

☎ 01 45 76 76 82

mail : comartex@comartex.fr



ADI S.p.A. Via Dell'Economia,12/16
 36016 Thiene (VI) Italy Tel. 0445 / 360244 Fax 0445/366862
 Fax Stone Division +39 0445/377555
 www.aditools.com E-mail: info@aditools.com



De la qualité, des prix et du choix...

La preuve en vidéo sur le

www.COMARTEX.com



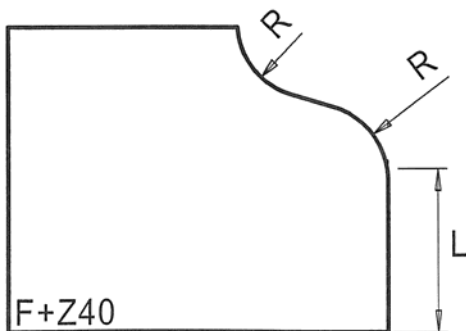

R= 10 mm L = 20 mm

FORO STANDARD 35 mm / Standard Bore 35 mm

-Spessore lastra 40 mm / Slab Thickness 40 mm

CODICE CODE	TIPO MOLA WHEEL TYPE	DIAMETRO DIAMETER	SEQUENZA SEQUENCE	POS	Prezzo Price [€uro]
PB01100	Settori / Segmented	120	1	1	542
PB01101	Fascia Continua / Continuous Rim		2	2	589
PB01102	Fascia Continua / Continuous Rim		3	3	589
PB02092	<i>Express</i>	105	4	6	236
PB02093	<i>Express</i>		5	7	236

COMARTEX

☎ 01 45 76 53 03

☎ 01 45 76 76 82

mail : comartex@comartex.fr



ADI S.p.A. Via Dell'Economia,12/16
 36016 Thiene (VI) Italy Tel. 0445 / 360244 Fax 0445/366862
 Fax Stone Division +39 0445/377555
www.aditools.com E-mail: info@aditools.com



De la qualité, des prix et du choix...

La preuve en vidéo sur le

www.COMARTEX.com



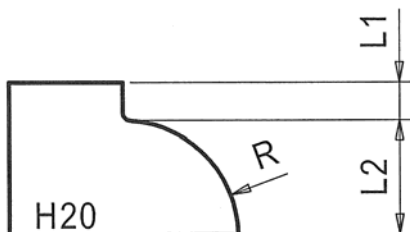

R= 15 mm L1 = 5 mm L2 =15 mm

FORO STANDARD 35 mm / Standard Bore 35 mm

-Spessore lastra 20 mm / Slab Thickness 20 mm

CODICE CODE	TIPO MOLA WHEEL TYPE	DIAMETRO DIAMETER	SEQUENZA SEQUENCE	POS	Prezzo Price [€uro]
PB01103	Settori / Segmented	120	1	1	428
PB01104	Fascia Continua / Continuous Rim		2	2	456
PB01105	Fascia Continua / Continuous Rim		3	3	456
PB02095	<i>Express</i>	90	4	6	194
PB02096	<i>Express</i>		5	7	194

COMARTEX

☎ 01 45 76 53 03

☎ 01 45 76 76 82

mail : comartex@comartex.fr



ADI S.p.A. Via Dell'Economia,12/16
 36016 Thiene (VI) Italy Tel. 0445 / 360244 Fax 0445/366862
 Fax Stone Division +39 0445/377555
 www.aditools.com E-mail: info@aditools.com



De la qualité, des prix et du choix...

La preuve en vidéo sur le

www.COMARTEX.com



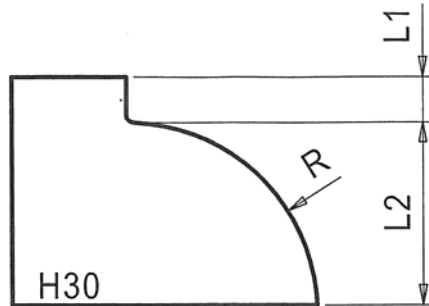

R= 25 mm L1 = 6 mm L2 =24 mm

FORO STANDARD 35 mm / Standard Bore 35 mm

-Spessore lastra 30 mm / Slab Thickness 30 mm

CODICE CODE	TIPO MOLA WHEEL TYPE	DIAMETRO DIAMETER	SEQUENZA SEQUENCE	POS	Prezzo Price [€uro]
PB01106	Settori / Segmented	120	1	1	475
PB01107	Fascia Continua / Continuous Rim		2	2	504
PB01108	Fascia Continua / Continuous Rim		3	3	504
PB02098	<i>Express</i>	110	4	6	214
PB02099	<i>Express</i>		5	7	214

COMARTEX

☎ 01 45 76 53 03
☎ 01 45 76 76 82
mail : comartex@comartex.fr



ADI S.p.A. Via Dell'Economia,12/16
36016 Thiene (VI) Italy Tel. 0445 / 360244 Fax 0445/366862
Fax Stone Division +39 0445/377555
www.aditools.com E-mail: info@aditools.com



De la qualité, des prix et du choix...

La preuve en vidéo sur le

www.COMARTEX.com



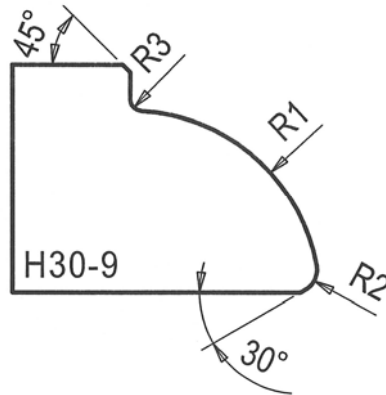

R1= 25 mm R2= 3 mm R3= 1,5 mm

FORO STANDARD 35 mm / Standard Bore 35 mm

-Spessore lastra 30 mm / Slab Thickness 30 mm

CODICE CODE	TIPO MOLA WHEEL TYPE	DIAMETRO DIAMETER	SEQUENZA SEQUENCE	POS	Prezzo Price [€uro]
PB01106	Settori / Segmented	110	1	1	475
PB01110	Fascia Continua / Continuous Rim		2	2	580
PB01111	Fascia Continua / Continuous Rim		3	3	580
PB02101	<i>Express</i>	110	4	6	245
PB02102	<i>Express</i>		5	7	245

COMARTEX

☎ 01 45 76 53 03
☎ 01 45 76 76 82
mail : comartex@comartex.fr



ADI S.p.A. Via Dell'Economia,12/16
36016 Thiene (VI) Italy Tel. 0445 / 360244 Fax 0445/366862
Fax Stone Division +39 0445/377555
www.aditools.com E-mail: info@aditools.com



De la qualité, des prix et du choix...

La preuve en vidéo sur le

www.COMARTEX.com



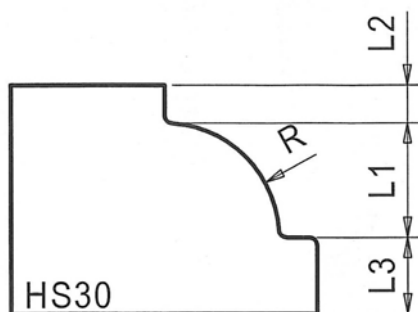

R= 15 mm L1= 15 mm L2= 5 mm L3= 10 mm

FORO STANDARD 35 mm / *Standard Bore 35 mm*

-Spessore lastra 30 mm / *Slab Thickness 30 mm*

CODICE CODE	TIPO MOLA WHEEL TYPE	DIAMETRO DIAMETER	SEQUENZA SEQUENCE	POS	Prezzo Price [€uro]
PB01112	Settori / Segmented	110	1	1	532
PB01113	Fascia Continua / <i>Continuous Rim</i>		2	2	532
PB01114	Fascia Continua / <i>Continuous Rim</i>		3	3	532
PB02104	<i>Express</i>	110	4	6	270
PB02105	<i>Express</i>		5	7	270

COMARTEX

☎ 01 45 76 53 03

☎ 01 45 76 76 82

mail : comartex@comartex.fr



ADI S.p.A. Via Dell'Economia,12/16
36016 Thiene (VI) Italy Tel. 0445 / 360244 Fax 0445/366862
Fax Stone Division +39 0445/377555
www.aditools.com E-mail: info@aditools.com



De la qualité, des prix et du choix...

La preuve en vidéo sur le

www.COMARTEX.com



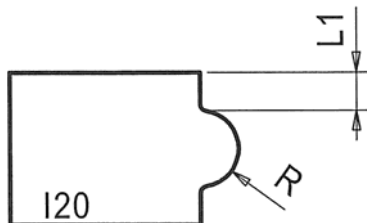

R= 5 mm L= 5 mm

FORO STANDARD 35 mm / Standard Bore 35 mm

-Spessore lastra 20 mm / Slab Thickness 20 mm

CODICE CODE	TIPO MOLA WHEEL TYPE	DIAMETRO DIAMETER	SEQUENZA SEQUENCE	POS	Prezzo Price [€uro]
PB01115	Settori / Segmented	120	1	1	442
PB01116	Fascia Continua / Continuous Rim		2	2	480
PB01117	Fascia Continua / Continuous Rim		3	3	480
PB02107	<i>Express</i>	95	4	6	174
PB02108	<i>Express</i>		5	7	174

COMARTEX

☎ 01 45 76 53 03

☎ 01 45 76 76 82

mail : comartex@comartex.fr



ADI S.p.A. Via Dell'Economia,12/16
 36016 Thiene (VI) Italy Tel. 0445 / 360244 Fax 0445/366862
 Fax Stone Division +39 0445/377555
 www.aditools.com E-mail: info@aditools.com



De la qualité, des prix et du choix...

La preuve en vidéo sur le

www.COMARTEX.com



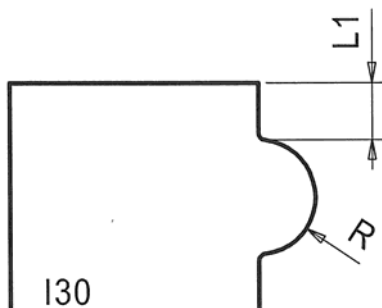

R= 7,5 mm L= 7,5 mm

FORO STANDARD 35 mm / Standard Bore 35 mm

-Spessore lastra 30 mm / Slab Thickness 30 mm

CODICE CODE	TIPO MOLA WHEEL TYPE	DIAMETRO DIAMETER	SEQUENZA SEQUENCE	POS	Prezzo Price [€uro]
PB01118	Settori / Segmented	120	1	1	489
PB01119	Fascia Continua / Continuous Rim		2	2	532
PB01120	Fascia Continua / Continuous Rim		3	3	532
PB02110	<i>Express</i>	100	4	6	205
PB02111	<i>Express</i>		5	7	205

COMARTEX

☎ 01 45 76 53 03

☎ 01 45 76 76 82

mail : comartex@comartex.fr



ADI S.p.A. Via Dell'Economia,12/16
36016 Thiene (VI) Italy Tel. 0445 / 360244 Fax 0445/366862
Fax Stone Division +39 0445/377555
www.aditools.com E-mail: info@aditools.com



De la qualité, des prix et du choix...

La preuve en vidéo sur le

www.COMARTEX.com



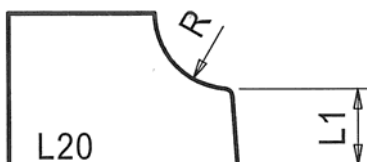

R= 10 mm L= 10 mm

FORO STANDARD 35 mm / Standard Bore 35 mm

-Spessore lastra 20 mm / Slab Thickness 20 mm

CODICE CODE	TIPO MOLA WHEEL TYPE	DIAMETRO DIAMETER	SEQUENZA SEQUENCE	POS	Prezzo Price [€uro]
PB01121	Settori / Segmented	120	1	1	428
PB01122	Fascia Continua / Continuous Rim		2	2	456
PB01123	Fascia Continua / Continuous Rim		3	3	456
PB02113	<i>Express</i>	80	4	6	173
PB02114	<i>Express</i>		5	7	173

COMARTEX

☎ 01 45 76 53 03

☎ 01 45 76 76 82

mail : comartex@comartex.fr



ADI S.p.A. Via Dell'Economia,12/16
 36016 Thiene (VI) Italy Tel. 0445 / 360244 Fax 0445/366862
 Fax Stone Division +39 0445/377555 40
www.aditools.com E-mail: info@aditools.com



De la qualité, des prix et du choix...

La preuve en vidéo sur le

www.COMARTEX.com



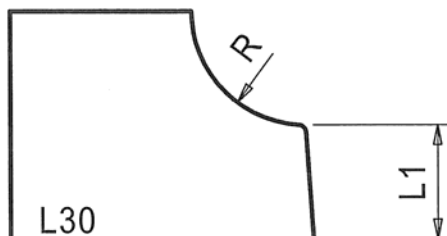

R= 15 mm L= 15 mm

FORO STANDARD 35 mm / Standard Bore 35 mm

-Spessore lastra 30 mm / Slab Thickness 30 mm

CODICE CODE	TIPO MOLA WHEEL TYPE	DIAMETRO DIAMETER	SEQUENZA SEQUENCE	POS	Prezzo Price [€uro]
PB01124	Settori / Segmented	120	1	1	475
PB01125	Fascia Continua / Continuous Rim		2	2	504
PB01126	Fascia Continua / Continuous Rim		3	3	504
PB02116	<i>Express</i>	100	4	6	206
PB02117	<i>Express</i>		5	7	206

COMARTEX

☎ 01 45 76 53 03

☎ 01 45 76 76 82

mail : comartex@comartex.fr



ADI S.p.A. Via Dell'Economia,12/16
 36016 Thiene (VI) Italy Tel. 0445 / 360244 Fax 0445/366862
 Fax Stone Division +39 0445/377555 41
www.aditools.com E-mail: info@aditools.com



De la qualité, des prix et du choix...

La preuve en vidéo sur le

www.COMARTEX.com



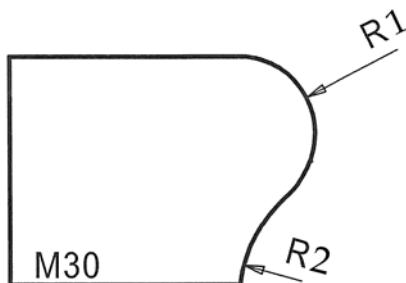

R1 = 11,25 mm R2 = 18,75 mm

FORO STANDARD 35 mm / *Standard Bore 35 mm*

-Spessore lastra 30 mm / *Slab Thickness 30 mm*

CODICE CODE	TIPO MOLA WHEEL TYPE	DIAMETRO DIAMETER	SEQUENZA SEQUENCE	POS	Prezzo Price [€uro]
PB01127	Settori / Segmented	120	1	1	546
PB01128	Fascia Continua / <i>Continuous Rim</i>		2	2	580
PB01129	Fascia Continua / <i>Continuous Rim</i>		3	3	580
PB02119	<i>Express</i>	90	4	6	214
PB02120	<i>Express</i>		5	7	214

COMARTEX

☎ 01 45 76 53 03

☎ 01 45 76 76 82

mail : comartex@comartex.fr



ADI S.p.A. Via Dell'Economia, 12/16
 36016 Thiene (VI) Italy Tel. 0445 / 360244 Fax 0445/366862
 Fax Stone Division +39 0445/377555
 www.aditools.com E-mail: info@aditools.com



De la qualité, des prix et du choix...

La preuve en vidéo sur le

www.COMARTEX.com



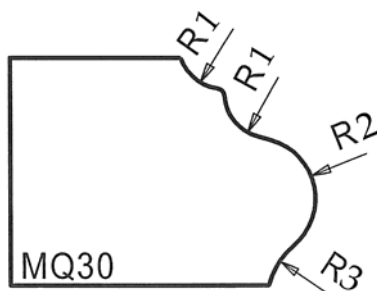

R1 = 6 mm R2 = 8 mm R3 = 10 mm

FORO STANDARD 35 mm / *Standard Bore 35 mm*

-Spessore lastra 30 mm / *Slab Thickness 30 mm*

CODICE CODE	TIPO MOLA WHEEL TYPE	DIAMETRO DIAMETER	SEQUENZA SEQUENCE	POS	Prezzo Price [€uro]
PB01130	Settori / Segmented	120	1	1	570
PB01131	Fascia Continua / <i>Continuous Rim</i>		2	2	604
PB01132	Fascia Continua / <i>Continuous Rim</i>		3	3	604
PB02122	<i>Express</i>	110	4	6	229
PB02123	<i>Express</i>		5	7	229

COMARTEX

☎ 01 45 76 53 03

☎ 01 45 76 76 82

mail : comartex@comartex.fr



ADI S.p.A. Via Dell'Economia, 12/16
 36016 Thiene (VI) Italy Tel. 0445 / 360244 Fax 0445/366862
 Fax Stone Division +39 0445/377555
 www.aditools.com E-mail: info@aditools.com



De la qualité, des prix et du choix...

La preuve en vidéo sur le

www.COMARTEX.com



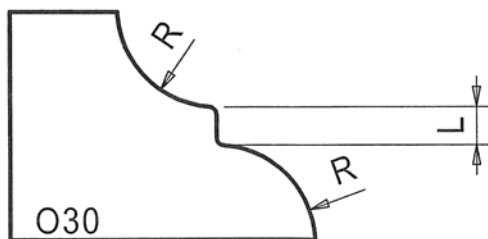

R= 13 mm L = 5 mm

FORO STANDARD 35 mm / Standard Bore 35 mm

-Spessore lastra 30 mm / Slab Thickness 30 mm

CODICE CODE	TIPO MOLA WHEEL TYPE	DIAMETRO DIAMETER	SEQUENZA SEQUENCE	POS	Prezzo Price [€uro]
PB01133	Settori / Segmented	120	1	1	523
PB01134	Fascia Continua / Continuous Rim		2	2	554
PB01135	Fascia Continua / Continuous Rim		3	3	554
PB02125	<i>Express</i>	115	4	6	245
PB02126	<i>Express</i>		5	7	245

COMARTEX

☎ 01 45 76 53 03

☎ 01 45 76 76 82

mail : comartex@comartex.fr



ADI S.p.A. Via Dell'Economia,12/16
36016 Thiene (VI) Italy Tel. 0445 / 360244 Fax 0445/366862
Fax Stone Division +39 0445/377555
www.aditools.com E-mail: info@aditools.com



De la qualité, des prix et du choix...

La preuve en vidéo sur le

www.COMARTEX.com



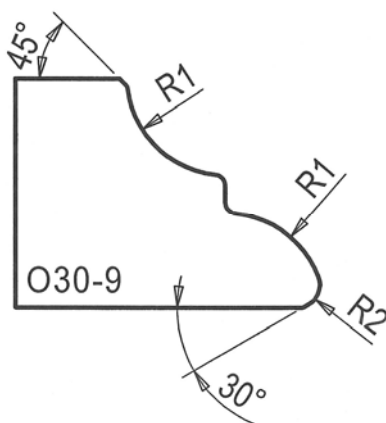

R1 = 13 mm R2 = 3 mm

FORO STANDARD 35 mm / Standard Bore 35 mm

-Spessore lastra 30 mm / Slab Thickness 30 mm

CODICE CODE	TIPO MOLA WHEEL TYPE	DIAMETRO DIAMETER	SEQUENZA SEQUENCE	POS	Prezzo Price [€uro]
PB01133	Settori / Segmented	120	1	1	523
PB01137	Fascia Continua / Continuous Rim		2	2	637
PB01138	Fascia Continua / Continuous Rim		3	3	637
PB02128	<i>Express</i>	115	4	6	282
PB02129	<i>Express</i>		5	7	282

COMARTEX

☎ 01 45 76 53 03

☎ 01 45 76 76 82

mail : comartex@comartex.fr



ADI S.p.A. Via Dell'Economia,12/16
 36016 Thiene (VI) Italy Tel. 0445 / 360244 Fax 0445/366862
 Fax Stone Division +39 0445/377555
 www.aditools.com E-mail: info@aditools.com



De la qualité, des prix et du choix...

La preuve en vidéo sur le

www. **COMARTEX** .com



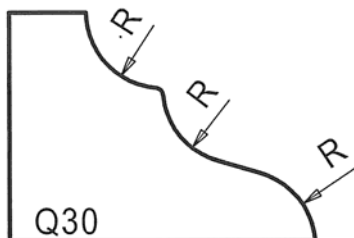

R= 10 mm

FORO STANDARD 35 mm / Standard Bore 35 mm

-Spessore lastra 30 mm / Slab Thickness 30 mm

CODICE CODE	TIPO MOLA WHEEL TYPE	DIAMETRO DIAMETER	SEQUENZA SEQUENCE	POS	Prezzo Price [€uro]
PB01142	Settori / Segmented	120	1	1	546
PB01143	Fascia Continua / Continuous Rim		2	2	580
PB01144	Fascia Continua / Continuous Rim		3	3	580
PB02131	<i>Express</i>	120	4	6	232
PB02132	<i>Express</i>		5	7	232

COMARTEX

☎ 01 45 76 53 03

☎ 01 45 76 76 82

mail : comartex@comartex.fr



ADI S.p.A. Via Dell'Economia,12/16
 36016 Thiene (VI) Italy Tel. 0445 / 360244 Fax 0445/366862
 Fax Stone Division +39 0445/377555
 www.aditools.com E-mail: info@aditools.com



De la qualité, des prix et du choix...

La preuve en vidéo sur le

www. **COMARTEX** .com



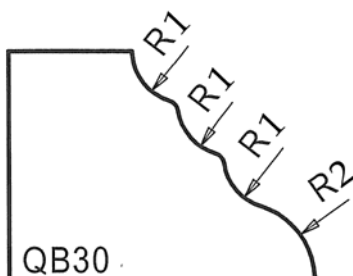

R1 = 7 mm R2 = 10 mm

FORO STANDARD 35 mm / Standard Bore 35 mm

-Spessore lastra 30 mm / Slab Thickness 30 mm

CODICE CODE	TIPO MOLA WHEEL TYPE	DIAMETRO DIAMETER	SEQUENZA SEQUENCE	POS	Prezzo Price [€uro]
PB01145	Settori / Segmented	120	1	1	546
PB01146	Fascia Continua / Continuous Rim		2	2	580
PB01147	Fascia Continua / Continuous Rim		3	3	580
PB02134	<i>Express</i>	110	4	6	234
PB02135	<i>Express</i>		5	7	234

COMARTEX

☎ 01 45 76 53 03

☎ 01 45 76 76 82

mail : comartex@comartex.fr



ADI S.p.A. Via Dell'Economia,12/16
 36016 Thiene (VI) Italy Tel. 0445 / 360244 Fax 0445/366862
 Fax Stone Division +39 0445/377555
 www.aditools.com E-mail: info@aditools.com



De la qualité, des prix et du choix...

La preuve en vidéo sur le

www.COMARTEX.com



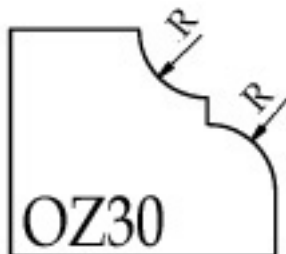

R= 9 mm

FORO STANDARD 35 mm / Standard Bore 35 mm

-Spessore lastra 30 mm / Slab Thickness 30 mm

CODICE CODE	TIPO MOLA WHEEL TYPE	DIAMETRO DIAMETER	SEQUENZA SEQUENCE	POS	Prezzo Price [€uro]
PB01139	Settori / Segmented	96	1	1	470
PB01140	Settori / Segmented		2	2	470
PB01141	Settori / Segmented		3	3	470
PB02137	<i>Express</i>	100	4	6	258
PB02138	<i>Express</i>		5	7	258

COMARTEX

☎ 01 45 76 53 03

☎ 01 45 76 76 82

mail : comartex@comartex.fr



ADI S.p.A. Via Dell'Economia,12/16
 36016 Thiene (VI) Italy Tel. 0445 / 360244 Fax 0445/366862
 Fax Stone Division +39 0445/377555 48
www.aditools.com E-mail: info@aditools.com



De la qualité, des prix et du choix...

La preuve en vidéo sur le

www.COMARTEX.com



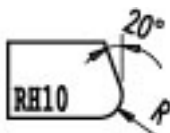

$$R = 3 \quad \alpha = 20^\circ$$

FORO STANDARD 35 mm / *Standard Bore 35 mm*

-Spessore lastra 10 mm / *Slab Thickness 10 mm*

CODICE CODE	TIPO MOLA WHEEL TYPE	DIAMETRO DIAMETER	SEQUENZA SEQUENCE	POS	Prezzo Price [€uro]
PB01226	Settori / Segmented	80	1	1	334
PB01227	Fascia Continua / <i>Continuous Rim</i>		2	2	334
PB01228	Fascia Continua / <i>Continuous Rim</i>		3	3	334
PB02227	<i>Express</i>	80	4	6	170
PB02228	<i>Express</i>		5	7	170

COMARTEX

☎ 01 45 76 53 03

☎ 01 45 76 76 82

mail : comartex@comartex.fr



ADI S.p.A. Via Dell'Economia, 12/16
 36016 Thiene (VI) Italy Tel. 0445 / 360244 Fax 0445/366862
 Fax Stone Division +39 0445/377555 49
 www.aditools.com E-mail: info@aditools.com



De la qualité, des prix et du choix...

La preuve en vidéo sur le

www.COMARTEX.com



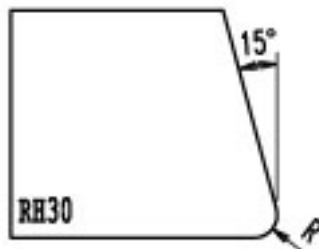

$$R = 3 \quad \alpha = 15^\circ$$

FORO STANDARD 35 mm / Standard Bore 35 mm

-Spessore lastra 30 mm / Slab Thickness 30 mm

CODICE CODE	TIPO MOLA WHEEL TYPE	DIAMETRO DIAMETER	SEQUENZA SEQUENCE	POS	Prezzo Price [€uro]
PB01229	Settori / Segmented	120	1	1	598
PB01230	Fascia Continua / Continuous Rim		2	2	602
PB01231	Fascia Continua / Continuous Rim		3	3	602
PB02230	<i>Express</i>	90	4	6	190
PB02231	<i>Express</i>		5	7	190

COMARTEX

☎ 01 45 76 53 03

☎ 01 45 76 76 82

mail : comartex@comartex.fr



ADI S.p.A. Via Dell'Economia, 12/16
 36016 Thiene (VI) Italy Tel. 0445 / 360244 Fax 0445/366862
 Fax Stone Division +39 0445/377555
 www.aditools.com E-mail: info@aditools.com



De la qualité, des prix et du choix...

La preuve en vidéo sur le

www.COMARTEX.com



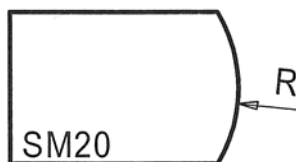

R = 20 mm S=20 mm

FORO STANDARD 35 mm / Standard Bore 35 mm

-Spessore lastra 20 mm / Slab Thickness 20 mm

CODICE CODE	TIPO MOLA WHEEL TYPE	DIAMETRO DIAMETER	SEQUENZA SEQUENCE	POS	Prezzo Price [€uro]
PB01148	Settori / Segmented	80	1	1	380
PB01149	Fascia Continua / Continuous Rim		2	2	380
PB01150	Fascia Continua / Continuous Rim		3	3	380
PB02140	<i>Express</i>	80	4	6	163
PB02141	<i>Express</i>		5	7	163

COMARTEX

☎ 01 45 76 53 03

☎ 01 45 76 76 82

mail : comartex@comartex.fr



ADI S.p.A. Via Dell'Economia,12/16
36016 Thiene (VI) Italy Tel. 0445 / 360244 Fax 0445/366862
Fax Stone Division +39 0445/377555
www.aditools.com E-mail: info@aditools.com



De la qualité, des prix et du choix...

La preuve en vidéo sur le

www.COMARTEX.com



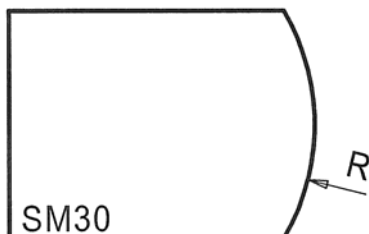

R = 30 mm S=30 mm

FORO STANDARD 35 mm / Standard Bore 35 mm

-Spessore lastra 30 mm / Slab Thickness 30 mm

CODICE CODE	TIPO MOLA WHEEL TYPE	DIAMETRO DIAMETER	SEQUENZA SEQUENCE	POS	Prezzo Price [€uro]
PB01151	Settori / Segmented	80	1	1	418
PB01152	Fascia Continua / Continuous Rim		2	2	418
PB01153	Fascia Continua / Continuous Rim		3	3	418
PB02143	<i>Express</i>	80	4	6	187
PB02144	<i>Express</i>		5	7	187

COMARTEX

☎ 01 45 76 53 03

☎ 01 45 76 76 82

mail : comartex@comartex.fr



ADI S.p.A. Via Dell'Economia,12/16
 36016 Thiene (VI) Italy Tel. 0445 / 360244 Fax 0445/366862
 Fax Stone Division +39 0445/377555
 www.aditools.com E-mail: info@aditools.com



De la qualité, des prix et du choix...

La preuve en vidéo sur le

www.COMARTEX.com



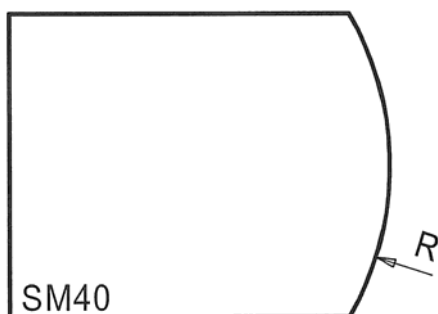

R = 40 mm S=40 mm

FORO STANDARD 35 mm / Standard Bore 35 mm

-Spessore lastra 40 mm / Slab Thickness 40 mm

CODICE CODE	TIPO MOLA WHEEL TYPE	DIAMETRO DIAMETER	SEQUENZA SEQUENCE	POS	Prezzo Price [€uro]
PB01154	Settori / Segmented	80	1	1	466
PB01155	Fascia Continua / Continuous Rim		2	2	466
PB01156	Fascia Continua / Continuous Rim		3	3	466
PB02146	<i>Express</i>	80	4	6	224
PB02147	<i>Express</i>		5	7	224

COMARTEX

☎ 01 45 76 53 03

☎ 01 45 76 76 82

mail : comartex@comartex.fr



ADI S.p.A. Via Dell'Economia,12/16
 36016 Thiene (VI) Italy Tel. 0445 / 360244 Fax 0445/366862
 Fax Stone Division +39 0445/377555
www.aditools.com E-mail: info@aditools.com



De la qualité, des prix et du choix...

La preuve en vidéo sur le

www.COMARTEX.com



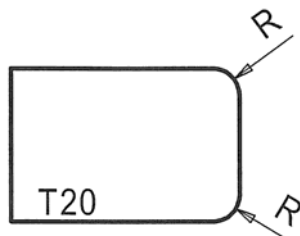

R= 5 mm

FORO STANDARD 35 mm / Standard Bore 35 mm

-Spessore lastra 20 mm / Slab Thickness 20 mm

CODICE CODE	TIPO MOLA WHEEL TYPE	DIAMETRO DIAMETER	SEQUENZA SEQUENCE	POS	Prezzo Price [€uro]
PB01157	Settori / Segmented	77	1	1	380
PB01158	Fascia Continua / Continuous Rim		2	2	380
PB01159	Fascia Continua / Continuous Rim		3	3	380
PB02149	<i>Express</i>	80	4	6	159
PB02150	<i>Express</i>		5	7	159

COMARTEX

☎ 01 45 76 53 03

☎ 01 45 76 76 82

mail : comartex@comartex.fr



ADI S.p.A. Via Dell'Economia,12/16
 36016 Thiene (VI) Italy Tel. 0445 / 360244 Fax 0445/366862
 Fax Stone Division +39 0445/377555
 www.aditools.com E-mail: info@aditools.com



De la qualité, des prix et du choix...

La preuve en vidéo sur le

www. **COMARTEX** .com



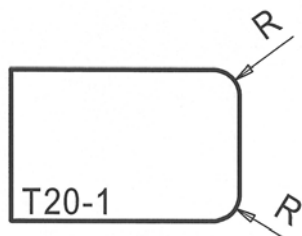

R= 3,5 mm

FORO STANDARD 35 mm / Standard Bore 35 mm

-Spessore lastra 20 mm / Slab Thickness 20 mm

CODICE CODE	TIPO MOLA WHEEL TYPE	DIAMETRO DIAMETER	SEQUENZA SEQUENCE	POS	Prezzo Price [€uro]
PB01160	Settori / Segmented	77	1	1	380
PB01161	Fascia Continua / Continuous Rim		2	2	380
PB01162	Fascia Continua / Continuous Rim		3	3	380
PB02152	<i>Express</i>	77	4	6	159
PB02153	<i>Express</i>		5	7	159

COMARTEX

☎ 01 45 76 53 03

☎ 01 45 76 76 82

mail : comartex@comartex.fr



ADI S.p.A. Via Dell'Economia,12/16
 36016 Thiene (VI) Italy Tel. 0445 / 360244 Fax 0445/366862
 Fax Stone Division +39 0445/377555
 www.aditools.com E-mail: info@aditools.com



De la qualité, des prix et du choix...

La preuve en vidéo sur le

www. **COMARTEX** .com



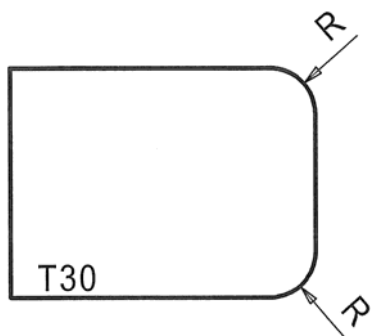

R = 6 mm

FORO STANDARD 35 mm / Standard Bore 35 mm

-Spessore lastra 30 mm / Slab Thickness 30 mm

CODICE CODE	TIPO MOLA WHEEL TYPE	DIAMETRO DIAMETER	SEQUENZA SEQUENCE	POS	Prezzo Price [€uro]
PB01166	Settori / Segmented	77	1	1	418
PB01167	Fascia Continua / Continuous Rim		2	2	418
PB01168	Fascia Continua / Continuous Rim		3	3	418
PB02155	<i>Express</i>	85	4	6	159
PB02156	<i>Express</i>		5	7	159

COMARTEX

☎ 01 45 76 53 03

☎ 01 45 76 76 82

mail : comartex@comartex.fr



ADI S.p.A. Via Dell'Economia, 12/16
 36016 Thiene (VI) Italy Tel. 0445 / 360244 Fax 0445/366862
 Fax Stone Division +39 0445/377555
 www.aditools.com E-mail: info@aditools.com



De la qualité, des prix et du choix...

La preuve en vidéo sur le

www. **COMARTEX** .com



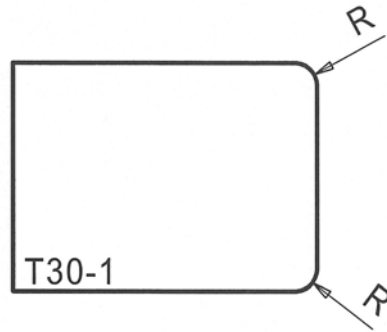

R = 3 mm

FORO STANDARD 35 mm / Standard Bore 35 mm

-Spessore lastra 30 mm / Slab Thickness 30 mm

CODICE CODE	TIPO MOLA WHEEL TYPE	DIAMETRO DIAMETER	SEQUENZA SEQUENCE	POS	Prezzo Price [€uro]
PB01163	Settori / Segmented	77	1	1	418
PB01164	Fascia Continua / Continuous Rim		2	2	418
PB01165	Fascia Continua / Continuous Rim		3	3	418
PB02158	<i>Express</i>	80	4	6	159
PB02159	<i>Express</i>		5	7	159

COMARTEX

☎ 01 45 76 53 03
☎ 01 45 76 76 82
mail : comartex@comartex.fr



ADI S.p.A. Via Dell'Economia, 12/16
36016 Thiene (VI) Italy Tel. 0445 / 360244 Fax 0445/366862
Fax Stone Division +39 0445/377555
www.aditools.com E-mail: info@aditools.com



De la qualité, des prix et du choix...

La preuve en vidéo sur le

www.COMARTEX.com



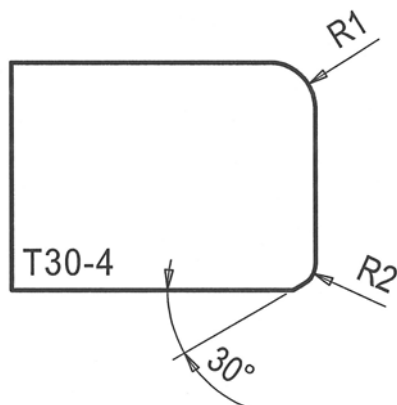

R1 = 6 mm R2 = 3 mm

FORO STANDARD 35 mm / *Standard Bore 35 mm*

-Spessore lastra 30 mm / *Slab Thickness 30 mm*

CODICE <i>CODE</i>	TIPO MOLA <i>WHEEL TYPE</i>	DIAMETRO <i>DIAMETER</i>	SEQUENZA <i>SEQUENCE</i>	POS	Prezzo Price [€uro]
PB01172	Settori / <i>Segmented</i>	77	1	1	418
PB01173	Fascia Continua / <i>Continuous Rim</i>		2	2	418
PB01174	Fascia Continua / <i>Continuous Rim</i>		3	3	418
PB02161	<i>Express</i>	85	4	6	172
PB02162	<i>Express</i>		5	7	172

COMARTEX

☎ 01 45 76 53 03

☎ 01 45 76 76 82

mail : comartex@comartex.fr



ADI S.p.A. Via Dell'Economia, 12/16
 36016 Thiene (VI) Italy Tel. 0445 / 360244 Fax 0445/366862
 Fax Stone Division +39 0445/377555
 www.aditools.com E-mail: info@aditools.com



De la qualité, des prix et du choix...

La preuve en vidéo sur le

www.COMARTEX.com



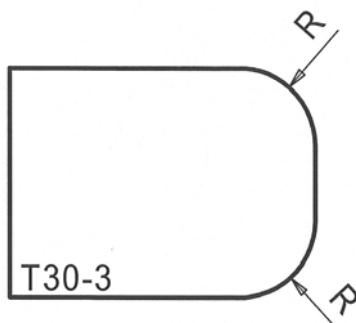

R= 10 mm

FORO STANDARD 35 mm / Standard Bore 35 mm

-Spessore lastra 30 mm / Slab Thickness 30 mm

CODICE CODE	TIPO MOLA WHEEL TYPE	DIAMETRO DIAMETER	SEQUENZA SEQUENCE	POS	Prezzo Price [€uro]
PB01169	Settori / Segmented	120	1	1	490
PB01170	Fascia Continua / Continuous Rim		2	2	532
PB01171	Fascia Continua / Continuous Rim		3	3	532
PB02167	<i>Express</i>	90	4	6	179
PB02168	<i>Express</i>		5	7	179

COMARTEX

☎ 01 45 76 53 03

☎ 01 45 76 76 82

mail : comartex@comartex.fr



ADI S.p.A. Via Dell'Economia,12/16
 36016 Thiene (VI) Italy Tel. 0445 / 360244 Fax 0445/366862
 Fax Stone Division +39 0445/377555
 www.aditools.com E-mail: info@aditools.com



De la qualité, des prix et du choix...

La preuve en vidéo sur le

www. **COMARTEX** .com



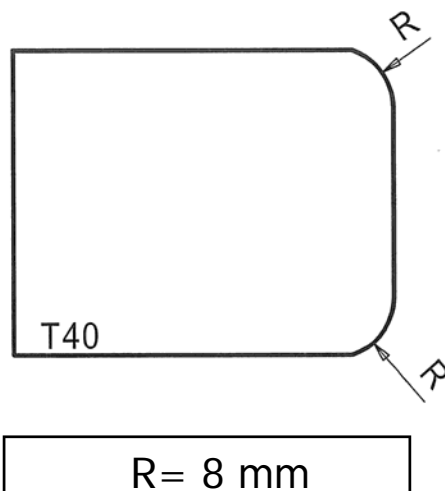

FORO STANDARD 35 mm / Standard Bore 35 mm

-Spessore lastra 40 mm / Slab Thickness 40 mm

CODICE CODE	TIPO MOLA WHEEL TYPE	DIAMETRO DIAMETER	SEQUENZA SEQUENCE	POS	Prezzo Price [€uro]
PB01178	Settori / Segmented	120	1	1	542
PB01179	Fascia Continua / Continuous Rim		2	2	589
PB01180	Fascia Continua / Continuous Rim		3	3	589
PB02170	<i>Express</i>	90	4	6	214
PB02171	<i>Express</i>		5	7	214

COMARTEX

☎ 01 45 76 53 03

☎ 01 45 76 76 82

mail : comartex@comartex.fr



ADI S.p.A. Via Dell'Economia,12/16
 36016 Thiene (VI) Italy Tel. 0445 / 360244 Fax 0445/366862
 Fax Stone Division +39 0445/377555
 www.aditools.com E-mail: info@aditools.com



De la qualité, des prix et du choix...

La preuve en vidéo sur le

www. **COMARTEX** .com



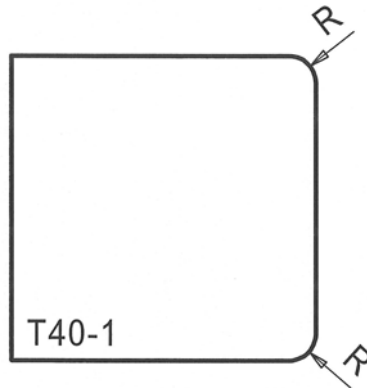

R= 3,5 mm

FORO STANDARD 35 mm / Standard Bore 35 mm

-Spessore lastra 40 mm / Slab Thickness 40 mm

CODICE CODE	TIPO MOLA WHEEL TYPE	DIAMETRO DIAMETER	SEQUENZA SEQUENCE	POS	Prezzo Price [€uro]
PB01175	Settori / Segmented	77	1	1	466
PB01176	Fascia Continua / Continuous Rim		2	2	466
PB01177	Fascia Continua / Continuous Rim		3	3	466
PB02164	<i>Express</i>	75	4	6	179
PB02165	<i>Express</i>		5	7	179

COMARTEX

☎ 01 45 76 53 03
☎ 01 45 76 76 82
mail : comartex@comartex.fr



ADI S.p.A. Via Dell'Economia,12/16
36016 Thiene (VI) Italy Tel. 0445 / 360244 Fax 0445/366862
Fax Stone Division +39 0445/377555
www.aditools.com E-mail: info@aditools.com



De la qualité, des prix et du choix...

La preuve en vidéo sur le

www.COMARTEX.com





R= 10 mm

FORO STANDARD 35 mm / Standard Bore 35 mm

-Spessore lastra 20 mm / Slab Thickness 20 mm

CODICE CODE	TIPO MOLA WHEEL TYPE	DIAMETRO DIAMETER	SEQUENZA SEQUENCE	POS	Prezzo Price [€uro]
PB01181	Settori / Segmented	86	1	1	390
PB01182	Fascia Continua / Continuous Rim		2	2	371
PB01183	Fascia Continua / Continuous Rim		3	3	371
PB02173	<i>Express</i>	100	4	6	159
PB02174	<i>Express</i>		5	7	159

COMARTEX

☎ 01 45 76 53 03

☎ 01 45 76 76 82

mail : comartex@comartex.fr



ADI S.p.A. Via Dell'Economia,12/16
 36016 Thiene (VI) Italy Tel. 0445 / 360244 Fax 0445/366862
 Fax Stone Division +39 0445/377555
 www.aditools.com E-mail: info@aditools.com



De la qualité, des prix et du choix...

La preuve en vidéo sur le

www. **COMARTEX** .com



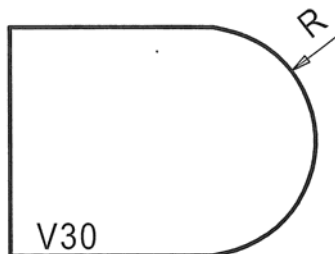

R= 15 mm

FORO STANDARD 35 mm / Standard Bore 35 mm

-Spessore lastra 30 mm / Slab Thickness 30 mm

CODICE CODE	TIPO MOLA WHEEL TYPE	DIAMETRO DIAMETER	SEQUENZA SEQUENCE	POS	Prezzo Price [€uro]
PB01184	Settori / Segmented	96	1	1	428
PB01185	Fascia Continua / Continuous Rim		2	2	422
PB01186	Fascia Continua / Continuous Rim		3	3	422
PB02176	<i>Express</i>	100	4	6	179
PB02177	<i>Express</i>		5	7	179

COMARTEX

☎ 01 45 76 53 03

☎ 01 45 76 76 82

mail : comartex@comartex.fr



ADI S.p.A. Via Dell'Economia,12/16
 36016 Thiene (VI) Italy Tel. 0445 / 360244 Fax 0445/366862
 Fax Stone Division +39 0445/377555
 www.aditools.com E-mail: info@aditools.com



De la qualité, des prix et du choix...

La preuve en vidéo sur le

www. **COMARTEX** .com



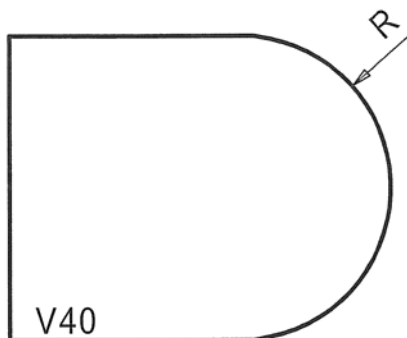

R= 20 mm

FORO STANDARD 35 mm / Standard Bore 35 mm

-Spessore lastra 40 mm / Slab Thickness 40 mm

CODICE CODE	TIPO MOLA WHEEL TYPE	DIAMETRO DIAMETER	SEQUENZA SEQUENCE	POS	Prezzo Price [€uro]
PB01187	Settori / Segmented	120	1	1	542
PB01188	Fascia Continua / Continuous Rim		2	2	590
PB01189	Fascia Continua / Continuous Rim		3	3	590
PB02179	<i>Express</i>	108	4	6	199
PB02180	<i>Express</i>		5	7	199

COMARTEX

☎ 01 45 76 53 03

☎ 01 45 76 76 82

mail : comartex@comartex.fr



ADI S.p.A. Via Dell'Economia,12/16
 36016 Thiene (VI) Italy Tel. 0445 / 360244 Fax 0445/366862
 Fax Stone Division +39 0445/377555
 www.aditools.com E-mail: info@aditools.com



De la qualité, des prix et du choix...

La preuve en vidéo sur le

www. **COMARTEX** .com



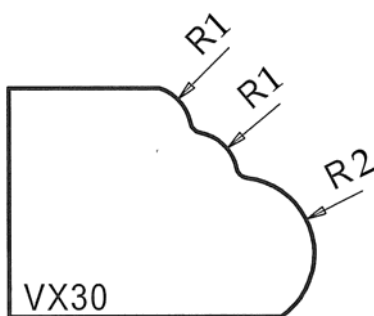

R1 = 6 mm R2 = 10 mm

FORO STANDARD 35 mm / Standard Bore 35 mm

-Spessore lastra 30 mm / Slab Thickness 30 mm

CODICE CODE	TIPO MOLA WHEEL TYPE	DIAMETRO DIAMETER	SEQUENZA SEQUENCE	POS	Prezzo Price [€uro]
PB01190	Settori / Segmented	120	1	1	587
PB01191	Fascia Continua / Continuous Rim		2	2	638
PB01192	Fascia Continua / Continuous Rim		3	3	638
PB02182	<i>Express</i>	110	4	6	236
PB02183	<i>Express</i>		5	7	236

COMARTEX

☎ 01 45 76 53 03
☎ 01 45 76 76 82
mail : comartex@comartex.fr



ADI S.p.A. Via Dell'Economia, 12/16
36016 Thiene (VI) Italy Tel. 0445 / 360244 Fax 0445/366862
Fax Stone Division +39 0445/377555
www.aditools.com E-mail: info@aditools.com



De la qualité, des prix et du choix...

La preuve en vidéo sur le

www.COMARTEX.com



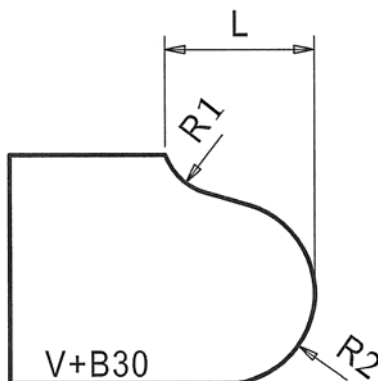

R1=8 mm R2 = 12 mm L = 20 mm

FORO STANDARD 35 mm / Standard Bore 35 mm

-Spessore lastra 30 mm / Slab Thickness 30 mm

CODICE CODE	TIPO MOLA WHEEL TYPE	DIAMETRO DIAMETER	SEQUENZA SEQUENCE	POS	Prezzo Price [€uro]
PB01193	Settori / Segmented	120	1	1	570
PB01194	Fascia Continua / Continuous Rim		2	2	604
PB01195	Fascia Continua / Continuous Rim		3	3	604
PB02185	<i>Express</i>	100	4	6	236
PB02186	<i>Express</i>		5	7	236

COMARTEX

☎ 01 45 76 53 03

☎ 01 45 76 76 82

mail : comartex@comartex.fr



ADI S.p.A. Via Dell'Economia,12/16
 36016 Thiene (VI) Italy Tel. 0445 / 360244 Fax 0445/366862
 Fax Stone Division +39 0445/377555
 www.aditools.com E-mail: info@aditools.com



De la qualité, des prix et du choix...

La preuve en vidéo sur le

www. **COMARTEX** .com



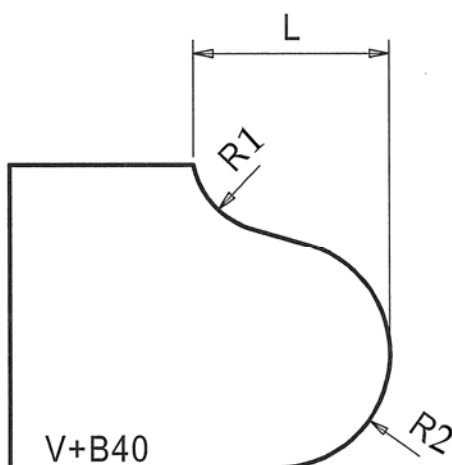

R1=11 mm R2 = 15 mm L = 26 mm

FORO STANDARD 35 mm / *Standard Bore 35 mm*

-Spessore lastra 40 mm / *Slab Thickness 40 mm*

CODICE <i>CODE</i>	TIPO MOLA <i>WHEEL TYPE</i>	DIAMETRO <i>DIAMETER</i>	SEQUENZA <i>SEQUENCE</i>	POS	Prezzo Price [€uro]
PB01196	Settori / <i>Segmented</i>	120	1	1	656
PB01197	Fascia Continua / <i>Continuous Rim</i>		2	2	690
PB01198	Fascia Continua / <i>Continuous Rim</i>		3	3	690
PB02188	<i>Express</i>	110	4	6	265
PB02189	<i>Express</i>		5	7	265

COMARTEX

☎ 01 45 76 53 03

☎ 01 45 76 76 82

mail : comartex@comartex.fr



ADI S.p.A. Via Dell'Economia,12/16
 36016 Thiene (VI) Italy Tel. 0445 / 360244 Fax 0445/366862
 Fax Stone Division +39 0445/377555
 www.aditools.com E-mail: info@aditools.com



De la qualité, des prix et du choix...

La preuve en vidéo sur le

www.COMARTEX.com





1A1(Z)20

L= 20 mm

FORO STANDARD 35 mm / Standard Bore 35 mm

-Spessore lastra 20 mm / Slab Thickness 20 mm

CODICE CODE	TIPO MOLA WHEEL TYPE	DIAMETRO DIAMETER	SEQUENZA SEQUENCE	POS	Prezzo Price [€uro]
PB01013	<i>SUPER "Z"</i>	60x35	1	1	304
PB01011	<i>Fascia Continua / Continuous Rim</i>	60x25	2	2	266
PB01012	<i>Fascia Continua / Continuous Rim</i>		3	3	266
PB02191	<i>Express</i>	60	4	6	151
PB02192	<i>Express</i>		5	7	151

COMARTEX

☎ 01 45 76 53 03

☎ 01 45 76 76 82

mail : comartex@comartex.fr



ADI S.p.A. Via Dell'Economia,12/16
 36016 Thiene (VI) Italy Tel. 0445 / 360244 Fax 0445/366862
 Fax Stone Division +39 0445/377555
 www.aditools.com E-mail: info@aditools.com



De la qualité, des prix et du choix...

La preuve en vidéo sur le

www.COMARTEX.com



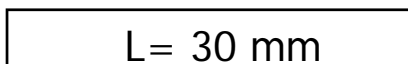
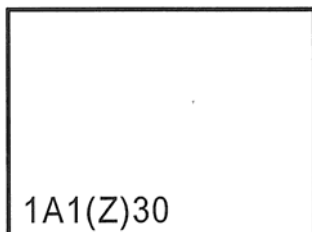

FORO STANDARD 35 mm / Standard Bore 35 mm

-Spessore lastra 30 mm / Slab Thickness 30 mm

CODICE CODE	TIPO MOLA WHEEL TYPE	DIAMETRO DIAMETER	SEQUENZA SEQUENCE	POS	Prezzo Price [€uro]
PB01013	<i>SUPER "Z"</i>	60	1	1	304
PB01014	<i>Fascia Continua / Continuous Rim</i>	60	2	2	304
PB01015	<i>Fascia Continua / Continuous Rim</i>		3	3	304
PB02193	<i>Express</i>	60	4	6	162
PB02194	<i>Express</i>		5	7	162

COMARTEX

☎ 01 45 76 53 03

☎ 01 45 76 76 82

mail : comartex@comartex.fr



ADI S.p.A. Via Dell'Economia,12/16
 36016 Thiene (VI) Italy Tel. 0445 / 360244 Fax 0445/366862
 Fax Stone Division +39 0445/377555
 www.aditools.com E-mail: info@aditools.com



De la qualité, des prix et du choix...

La preuve en vidéo sur le

www.COMARTEX.com



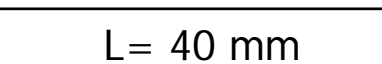
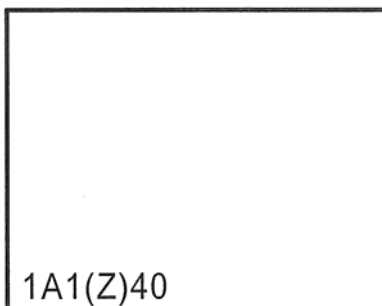

FORO STANDARD 35 mm / Standard Bore 35 mm

-Spessore lastra 40 mm / Slab Thickness 40 mm

CODICE CODE	TIPO MOLA WHEEL TYPE	DIAMETRO DIAMETER	SEQUENZA SEQUENCE	POS	Prezzo Price [€uro]
PB01016	<i>SUPER "Z"</i>	60	1	1	352
PB01017	<i>Fascia Continua / Continuous Rim</i>	60	2	2	352
PB01018	<i>Fascia Continua / Continuous Rim</i>		3	3	352
PB02196	<i>Express</i>	60	4	6	188
PB02197	<i>Express</i>		5	7	188

COMARTEX

☎ 01 45 76 53 03

☎ 01 45 76 76 82

mail : comartex@comartex.fr



ADI S.p.A. Via Dell'Economia,12/16
 36016 Thiene (VI) Italy Tel. 0445 / 360244 Fax 0445/366862
 Fax Stone Division +39 0445/377555
 www.aditools.com E-mail: info@aditools.com



De la qualité, des prix et du choix...

La preuve en vidéo sur le

www.COMARTEX.com



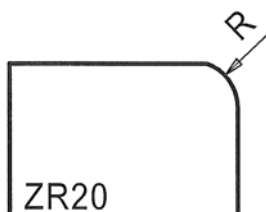

R= 5 mm

FORO STANDARD 35 mm / Standard Bore 35 mm

-Spessore lastra 20 mm / Slab Thickness 20 mm

CODICE CODE	TIPO MOLA WHEEL TYPE	DIAMETRO DIAMETER	SEQUENZA SEQUENCE	POS	Prezzo Price [€uro]
PB01199	Fascia Continua / Continuous Rim	82	1	1	380
PB01200	Fascia Continua / Continuous Rim		2	2	380
PB01201	Fascia Continua / Continuous Rim		3	3	380
PB02200	<i>Express</i>	90	4	6	150
PB02201	<i>Express</i>		5	7	150

COMARTEX

☎ 01 45 76 53 03

☎ 01 45 76 76 82

mail : comartex@comartex.fr



ADI S.p.A. Via Dell'Economia,12/16
36016 Thiene (VI) Italy Tel. 0445 / 360244 Fax 0445/366862
Fax Stone Division +39 0445/377555
www.aditools.com E-mail: info@aditools.com



De la qualité, des prix et du choix...

La preuve en vidéo sur le

www.COMARTEX.com



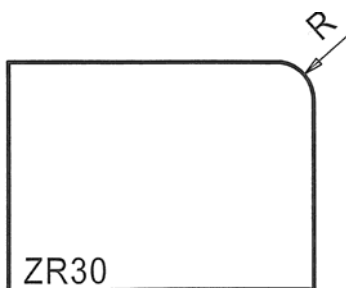

R = 5 mm

FORO STANDARD 35 mm / *Standard Bore 35 mm*

-Spessore lastra 30 mm / *Slab Thickness 30 mm*

CODICE <i>CODE</i>	TIPO MOLA <i>WHEEL TYPE</i>	DIAMETRO <i>DIAMETER</i>	SEQUENZA <i>SEQUENCE</i>	POS	Prezzo Price [€uro]
PB01202	Fascia Continua / <i>Continuous Rim</i>	80	1	1	418
PB01203	Fascia Continua / <i>Continuous Rim</i>		2	2	418
PB01204	Fascia Continua / <i>Continuous Rim</i>		3	3	418
PB02203	<i>Express</i>	90	4	6	163
PB02204	<i>Express</i>		5	7	163

COMARTEX

☎ 01 45 76 53 03

☎ 01 45 76 76 82

mail : comartex@comartex.fr



ADI S.p.A. Via Dell'Economia, 12/16
 36016 Thiene (VI) Italy Tel. 0445 / 360244 Fax 0445/366862
 Fax Stone Division +39 0445/377555
 www.aditools.com E-mail: info@aditools.com



De la qualité, des prix et du choix...

La preuve en vidéo sur le

www.COMARTEX.com



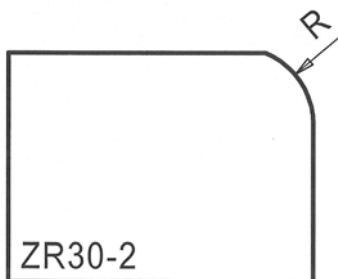

R= 10 mm

FORO STANDARD 35 mm / Standard Bore 35 mm

-Spessore lastra 30 mm / Slab Thickness 30 mm

CODICE CODE	TIPO MOLA WHEEL TYPE	DIAMETRO DIAMETER	SEQUENZA SEQUENCE	POS	Prezzo Price [€uro]
PB01205	Fascia Continua / Continuous Rim	93	1	1	418
PB01206	Fascia Continua / Continuous Rim		2	2	418
PB01207	Fascia Continua / Continuous Rim		3	3	418
PB02206	<i>Express</i>	93	4	6	163
PB02207	<i>Express</i>		5	7	163

COMARTEX

☎ 01 45 76 53 03

☎ 01 45 76 76 82

mail : comartex@comartex.fr



ADI S.p.A. Via Dell'Economia,12/16
 36016 Thiene (VI) Italy Tel. 0445 / 360244 Fax 0445/366862
 Fax Stone Division +39 0445/377555
 www.aditools.com E-mail: info@aditools.com



De la qualité, des prix et du choix...

La preuve en vidéo sur le

www. **COMARTEX** .com



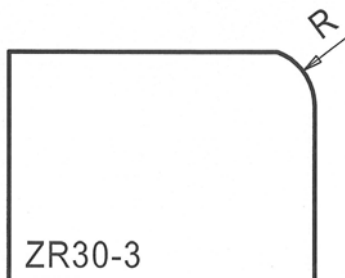

R = 7,5 mm

FORO STANDARD 35 mm / Standard Bore 35 mm

-Spessore lastra 30 mm / Slab Thickness 30 mm

CODICE CODE	TIPO MOLA WHEEL TYPE	DIAMETRO DIAMETER	SEQUENZA SEQUENCE	POS	Prezzo Price [€uro]
PB01208	Fascia Continua / Continuous Rim	80	1	1	418
PB01209	Fascia Continua / Continuous Rim		2	2	418
PB01210	Fascia Continua / Continuous Rim		3	3	418
PB02209	<i>Express</i>	93	4	6	163
PB02210	<i>Express</i>		5	7	163

COMARTEX

☎ 01 45 76 53 03

☎ 01 45 76 76 82

mail : comartex@comartex.fr



ADI S.p.A. Via Dell'Economia,12/16
 36016 Thiene (VI) Italy Tel. 0445 / 360244 Fax 0445/366862
 Fax Stone Division +39 0445/377555
 www.aditools.com E-mail: info@aditools.com



De la qualité, des prix et du choix...

La preuve en vidéo sur le

www. **COMARTEX** .com





R= 5 mm

FORO STANDARD 35 mm / Standard Bore 35 mm

-Spessore lastra 40 mm / Slab Thickness 40 mm

CODICE CODE	TIPO MOLA WHEEL TYPE	DIAMETRO DIAMETER	SEQUENZA SEQUENCE	POS	Prezzo Price [€uro]
PB01211	Fascia Continua / Continuous Rim	80	1	1	466
PB01212	Fascia Continua / Continuous Rim		2	2	466
PB01213	Fascia Continua / Continuous Rim		3	3	466
PB02212	<i>Express</i>	95	4	6	206
PB02213	<i>Express</i>		5	7	206

COMARTEX

☎ 01 45 76 53 03

☎ 01 45 76 76 82

mail : comartex@comartex.fr



ADI S.p.A. Via Dell'Economia,12/16
36016 Thiene (VI) Italy Tel. 0445 / 360244 Fax 0445/366862
Fax Stone Division +39 0445/377555
www.aditools.com E-mail: info@aditools.com



De la qualité, des prix et du choix...

La preuve en vidéo sur le

www.COMARTEX.com



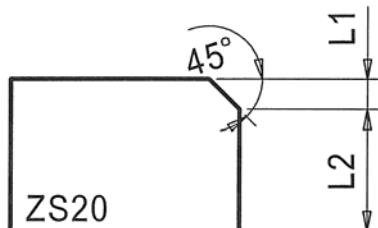

L1 = 4 mm L2 = 16 mm

FORO STANDARD 35 mm / *Standard Bore 35 mm*

-Spessore lastra 20 mm / *Slab Thickness 20 mm*

CODICE <i>CODE</i>	TIPO MOLA <i>WHEEL TYPE</i>	DIAMETRO <i>DIAMETER</i>	SEQUENZA <i>SEQUENCE</i>	POS	Prezzo Price [€uro]
PB01214	Fascia Continua / <i>Continuous Rim</i>	82	1	1	380
PB01215	Fascia Continua / <i>Continuous Rim</i>		2	2	380
PB01216	Fascia Continua / <i>Continuous Rim</i>		3	3	380
PB02215	<i>Express</i>	70	4	6	164
PB02216	<i>Express</i>		5	7	164

COMARTEX

☎ 01 45 76 53 03

☎ 01 45 76 76 82

mail : comartex@comartex.fr



ADI S.p.A. Via Dell'Economia, 12/16
 36016 Thiene (VI) Italy Tel. 0445 / 360244 Fax 0445/366862
 Fax Stone Division +39 0445/377555
 www.aditools.com E-mail: info@aditools.com



De la qualité, des prix et du choix...

La preuve en vidéo sur le

www.COMARTEX.com



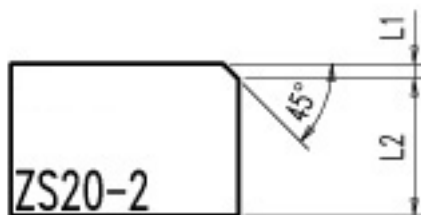

L1 = 2 mm L2 = 18 mm

FORO STANDARD 35 mm / Standard Bore 35 mm

-Spessore lastra 20 mm / Slab Thickness 20 mm

CODICE CODE	TIPO MOLA WHEEL TYPE	DIAMETRO DIAMETER	SEQUENZA SEQUENCE	POS	Prezzo Price [€uro]
PB01232	Fascia Continua / Continuous Rim	82	1	1	380
PB01233	Fascia Continua / Continuous Rim		2	2	380
PB01234	Fascia Continua / Continuous Rim		3	3	380
PB02233	<i>Express</i>	70	4	6	164
PB02234	<i>Express</i>		5	7	164

COMARTEX

☎ 01 45 76 53 03

☎ 01 45 76 76 82

mail : comartex@comartex.fr



ADI S.p.A. Via Dell'Economia, 12/16
 36016 Thiene (VI) Italy Tel. 0445 / 360244 Fax 0445/366862
 Fax Stone Division +39 0445/377555
 www.aditools.com E-mail: info@aditools.com



De la qualité, des prix et du choix...

La preuve en vidéo sur le

www.COMARTEX.com



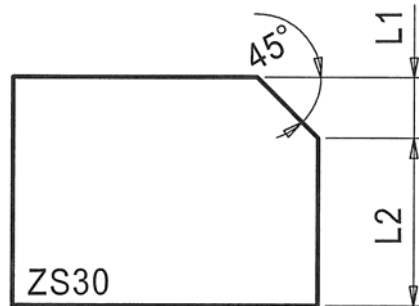

L1 = 8 mm L2 = 22 mm

FORO STANDARD 35 mm / Standard Bore 35 mm

-Spessore lastra 30 mm / Slab Thickness 30 mm

CODICE CODE	TIPO MOLA WHEEL TYPE	DIAMETRO DIAMETER	SEQUENZA SEQUENCE	POS	Prezzo Price [€uro]
PB01217	Fascia Continua / Continuous Rim	90	1	1	418
PB01218	Fascia Continua / Continuous Rim		2	2	418
PB01219	Fascia Continua / Continuous Rim		3	3	418
PB02218	<i>Express</i>	70	4	6	191
PB02219	<i>Express</i>		5	7	191

COMARTEX

☎ 01 45 76 53 03

☎ 01 45 76 76 82

mail : comartex@comartex.fr



ADI S.p.A. Via Dell'Economia, 12/16
 36016 Thiene (VI) Italy Tel. 0445 / 360244 Fax 0445/366862
 Fax Stone Division +39 0445/377555
 www.aditools.com E-mail: info@aditools.com



De la qualité, des prix et du choix...

La preuve en vidéo sur le

www.COMARTEX.com



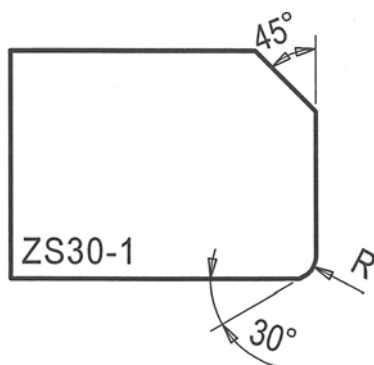

L1= 8 mm L2=22 mm R= 3 mm

FORO STANDARD 35 mm / Standard Bore 35 mm

-Spessore lastra 30 mm / Slab Thickness 30 mm

CODICE CODE	TIPO MOLA WHEEL TYPE	DIAMETRO DIAMETER	SEQUENZA SEQUENCE	POS	Prezzo Price [€uro]
PB01220	Fascia Continua / Continuous Rim	90	1	1	418
PB01221	Fascia Continua / Continuous Rim		2	2	460
PB01222	Fascia Continua / Continuous Rim		3	3	460
PB02221	<i>Express</i>	70	4	6	218
PB02222	<i>Express</i>		5	7	218

COMARTEX

☎ 01 45 76 53 03

☎ 01 45 76 76 82

mail : comartex@comartex.fr



ADI S.p.A. Via Dell'Economia,12/16
 36016 Thiene (VI) Italy Tel. 0445 / 360244 Fax 0445/366862
 Fax Stone Division +39 0445/377555
 www.aditools.com E-mail: info@aditools.com



De la qualité, des prix et du choix...

La preuve en vidéo sur le

www. **COMARTEX** .com



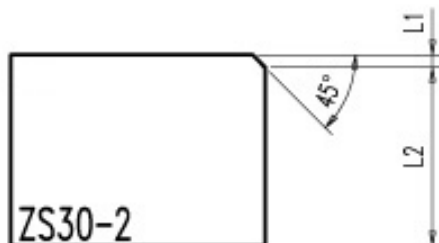

L1 = 2 mm L2 = 28 mm

FORO STANDARD 35 mm / *Standard Bore 35 mm*

-Spessore lastra 30 mm / *Slab Thickness 30 mm*

CODICE <i>CODE</i>	TIPO MOLA <i>WHEEL TYPE</i>	DIAMETRO <i>DIAMETER</i>	SEQUENZA <i>SEQUENCE</i>	POS	Prezzo Price [€uro]
PB01235	Fascia Continua / <i>Continuous Rim</i>	90	1	1	418
PB01236	Fascia Continua / <i>Continuous Rim</i>		2	2	418
PB01237	Fascia Continua / <i>Continuous Rim</i>		3	3	418
PB02236	<i>Express</i>	70	4	6	190
PB02237	<i>Express</i>		5	7	190

COMARTEX

☎ 01 45 76 53 03

☎ 01 45 76 76 82

mail : comartex@comartex.fr



ADI S.p.A. Via Dell'Economia, 12/16
 36016 Thiene (VI) Italy Tel. 0445 / 360244 Fax 0445/366862
 Fax Stone Division +39 0445/377555 80
 www.aditools.com E-mail: info@aditools.com



De la qualité, des prix et du choix...

La preuve en vidéo sur le

www.COMARTEX.com



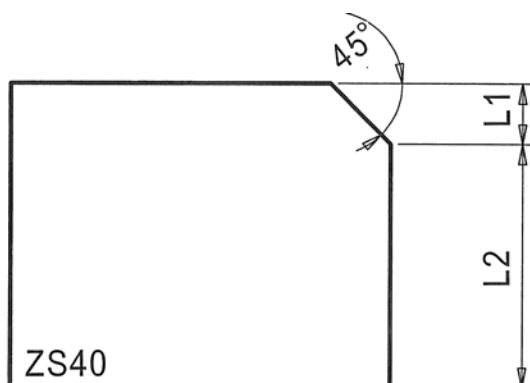

L1 = 8 mm L2 = 32 mm

FORO STANDARD 35 mm / Standard Bore 35 mm

-Spessore lastra 40 mm / Slab Thickness 40 mm

CODICE CODE	TIPO MOLA WHEEL TYPE	DIAMETRO DIAMETER	SEQUENZA SEQUENCE	POS	Prezzo Price [€uro]
PB01223	Fascia Continua / Continuous Rim	90	1	1	466
PB01224	Fascia Continua / Continuous Rim		2	2	466
PB01225	Fascia Continua / Continuous Rim		3	3	466
PB02224	<i>Express</i>	70	4	6	231
PB02225	<i>Express</i>		5	7	231

COMARTEX

☎ 01 45 76 53 03

☎ 01 45 76 76 82

mail : comartex@comartex.fr



ADI S.p.A. Via Dell'Economia,12/16
 36016 Thiene (VI) Italy Tel. 0445 / 360244 Fax 0445/366862
 Fax Stone Division +39 0445/377555
 www.aditools.com E-mail: info@aditools.com



De la qualité, des prix et du choix...

La preuve en vidéo sur le

www.COMARTEX.com



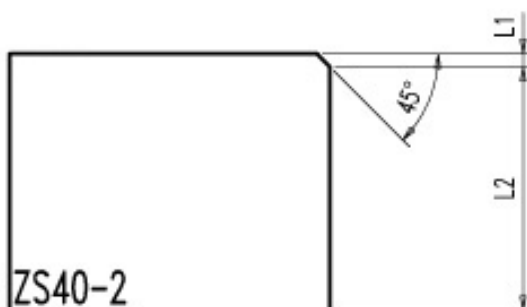

L1 = 2 mm L2 = 38 mm

FORO STANDARD 35 mm / Standard Bore 35 mm

-Spessore lastra 40 mm / Slab Thickness 40 mm

CODICE CODE	TIPO MOLA WHEEL TYPE	DIAMETRO DIAMETER	SEQUENZA SEQUENCE	POS	Prezzo Price [€uro]
PB01238	Fascia Continua / Continuous Rim	90	1	1	466
PB01239	Fascia Continua / Continuous Rim		2	2	466
PB01240	Fascia Continua / Continuous Rim		3	3	466
PB02239	<i>Express</i>	70	4	6	231
PB02240	<i>Express</i>		5	7	231

COMARTEX

☎ 01 45 76 53 03

☎ 01 45 76 76 82

mail : comartex@comartex.fr



ADI S.p.A. Via Dell'Economia, 12/16
 36016 Thiene (VI) Italy Tel. 0445 / 360244 Fax 0445/366862
 Fax Stone Division +39 0445/377555
 www.aditools.com E-mail: info@aditools.com



De la qualité, des prix et du choix...

La preuve en vidéo sur le

www.COMARTEX.com

